



KERN & Sohn GmbH

Ziegelei 1
D-72336 Balingen
E-Mail: info@kern-sohn.com

Phone: +49-[0]7433-9933-0
Fax: +49-[0]7433-9933-149
Internet: www.kern-sohn.com

Operating and Installation Instructions Display devices

KERN KFB / KFN-TAM

Version 3.1
01/2017
GB



KFB/KFN-TAM-BA_IA-e-1731



KERN KFB/KFN-TAM

Version 3.1 01/2017

Operating and installation instructions Display units

Contents

1	Technical data	4
2	Appliance overview	5
2.1	Keyboard overview	7
2.1.1	Numerical input via the navigation buttons.....	8
2.2	Overview of display	9
3	Basic Information (General)	10
3.1	Proper use	10
3.2	Improper Use.....	10
3.3	Warranty	10
3.4	Monitoring of Test Resources	11
4	Basic Safety Precautions	11
4.1	Pay attention to the instructions in the Operation Manual.....	11
4.2	Personnel training.....	11
5	Transport and storage	11
5.1	Testing upon acceptance	11
5.2	Packaging / return transport.....	11
6	Unpacking and placing	12
6.1	Installation Site, Location of Use	12
6.2	Unpacking and placing	12
6.3	Scope of delivery / serial accessories:	12
6.4	Transportation lock (illustration example).....	13
6.5	Error message	13
6.6	Mains connection.....	14
6.7	Storage battery operation (optional).....	14
6.8	Adjustment.....	15
6.8.1	Verified weighing systems.....	15
6.8.2	Non verifiable weighing systems	18
6.9	Linearization	19
6.9.1	Verified weighing systems:.....	19
6.9.2	Non-verified weighing systems.....	20
6.10	Verification	21

7	Operation	24
7.1	Start-up.....	24
7.2	Switching Off.....	24
7.3	Zeroing.....	24
7.4	Simple weighing.....	24
7.5	Switch-over weighing unit (only not verifiable weighing systems).....	25
7.6	Weighing with tare.....	26
7.7	Weighing with tolerance range.....	27
7.7.1	Tolerance check for target weight.....	28
7.7.2	Tolerance check for target quantity.....	30
7.8	Manual totalizing.....	32
7.9	Automatic adding-up.....	34
7.10	Parts counting.....	35
7.11	Animal weighing.....	36
7.12	Lock keyboard.....	37
7.13	Display background illumination.....	37
7.14	Automatic switch-off function „AUTO OFF“.....	38
8	Menu	39
8.1	Overview non verifiable weighing systems (contacts of circuit board [K1] not short-circuited).....	40
8.2	Overview verified weighing systems (contacts of circuit board [K1] short-circuited by means of jumper).....	43
9	Service, maintenance, disposal	47
9.1	Clean.....	47
9.2	Service, maintenance.....	47
9.3	Disposal.....	47
9.4	Error messages.....	47
10	Data output RS 232C	49
10.1	Technical data.....	49
10.2	Printer mode / Printout examples (KERN YKB-01N).....	49
10.3	Output log (continuous output).....	52
10.4	Remote control instructions.....	52
10.5	I/O-Function.....	53
11	Instant help	54
12	Installing display unit / weighing bridge	55
12.1	Technical data.....	55
12.2	Weighing system design.....	55
12.3	How to connect the platform.....	56
12.4	Configure display unit.....	57
12.4.1	Verified weighing systems (contacts of circuit board [K1] short-circuited by means of jumper).....	57
12.4.2	Non verifiable weighing systems (contacts of circuit board [K1] not short-circuited).....	63
13	Annex	67
13.1	Dimensions Support base / wall bracket.....	67
13.2	Declaration of Conformity / Examination Certificate	68

1 Technical data

KERN	KFB-TAM	KFN-TAM
Display	5 ½ - digit	
Resolution (verified)	6000	
	Single (Max.) 6.000 e	
	Dual (Max.) 3.000 e	
Resolution (non-verified)	30.000	
Weighing ranges	2	
Divisions	1,2,5,...10n	
Weighing Units	kg	
Functions	Weighing with tolerance range, Totalizing, Animal weighing	
Display	LCD 52 mm digits with back lighting	
DMS weighing cells	80-100 Ω. Max. 4 item per 350 Ω; Sensitivity 2-3 mV/V	
Range calibration	We recommend ≥ 50 % max.	
Data output	RS232	
Electric Supply	Input voltage 220 V – 240 V, 50 Hz	
	Power pack secondary voltage 12V, 500mA	
Housing	250 x 160 x 58	266 x 165 x 96
Admissible ambient temperature	0°C – 40°C (non-verified) -10°C – 40°C (verified)	
Net weight	1.5 kg	2 kg
Rechargeable battery (optional) Operating / charge time	35 h / 12 h	90 h / 12 h
RS 232 interface	Standard	Option
Tripod	KERN BFS-07, option	
Support base incl. wall bracket	Standard	
IP protection	-	IP 67 as per DIN 60529 (rechargeable battery operation only)

2 Appliance overview

KFB-TAM: Synthetic finish













1. Status of rechargeable battery
2. Keyboard
3. Weight display
4. Tolerance margin, see chap. 7.7
5. Weighing unit
6. RS-232
7. Input connection load cell cable
8. Guide rail support base / stand
9. End stop support base / stand
10. Mains adapter connection
11. Adjustment switch

KFN-TAM: Stainless steel finish



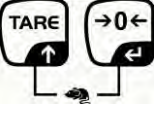
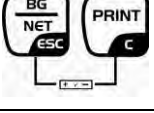
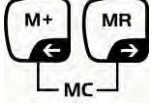

2.1 Keyboard overview

Key	Function
	<ul style="list-style-type: none"> • Turn on/off
 Navigation button 	<ul style="list-style-type: none"> • Zeroing • Confirm entry
 Navigation key 	<ul style="list-style-type: none"> • Taring • At numeric input increase flashing digit • Scroll forward in menu
 Navigation key 	<ul style="list-style-type: none"> • Display sum total • Digit selection to the right
 Navigation key 	<ul style="list-style-type: none"> • Add weighing value to summation memory • Digit selection to the left
 C	<ul style="list-style-type: none"> • Calculate weighing data via interface • Delete
 ESC	<ul style="list-style-type: none"> • Change between gross ⇔ and net weight • Back to menu/weighing mode
	<ul style="list-style-type: none"> • Call up animal weighing function
	<ul style="list-style-type: none"> • Call up weighing with tolerance range
 MC	<ul style="list-style-type: none"> • Delete total added memory

2.1.1 Numerical input via the navigation buttons

⇒ Press  and current setting will be displayed. The first digit will be flashing and is ready for changing.

⇒ If you do not wish to change the first digit, press  and the second digit will start flashing.



Each time you press , the display will move to the subsequent digit, after the last digit the display will return to the first digit.

⇒ To change the selected (flashing) digit, press  repeatedly until the desired value is displayed. Then press  to access further digits and change them by .

⇒ Complete your entry by .

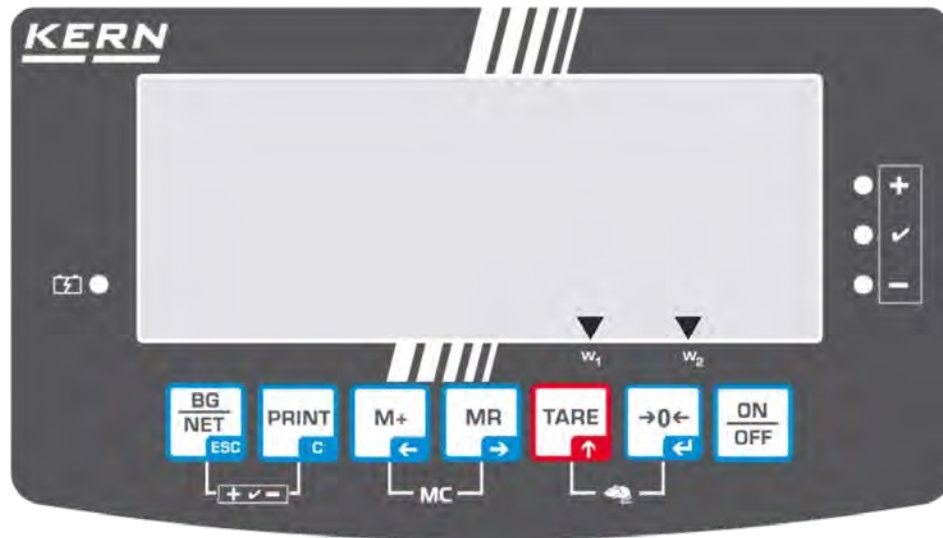
2.2 Overview of display



Display	Significance
	Weighing range 1
	Weighing range 2
	Battery very low
STABLE	Stability display
ZERO	Zero indicator
GROSS	Gross weight
NET	Net weight
AUTO	Automatic add-up enabled
Kg	Weighing unit
M+	Totalisation
LED + / ✓ / -	Indicators for weighing with tolerance range

3 Basic Information (General)

3.1 Proper use

The display unit acquired by you is used in combination with a weighing plate and serves to determine the weighing value of material to be weighed. It is intended to be used as a “non-automatic weighing system”, i.e. the material to be weighed is manually and carefully placed in the centre of the weighing plate. As soon as a stable weighing value is reached the weighing value can be read.

3.2 Improper Use

Do not use display unit for dynamic weighings. In the event that small quantities are removed or added to the material to be weighed, incorrect weighing results can be displayed due to the “stability compensation“ in the display unit. (Example: Slowly draining fluids from a container on the balance.)

Do not leave permanent load on the weighing pan. This may damage the measuring system.

Impacts and overloading exceeding the stated maximum load (max) of the weighing plate, minus a possibly existing tare load, must be strictly avoided. Both, the weighing plate and the display unit may be damaged during this process.

Never operate display unit in explosive environment. The serial version is not explosion protected.

Changes to the display unit's design are not permitted. This may lead to incorrect weighing results, safety-related faults and destruction of the display unit.

The display unit may only be operated in accordance with the described default settings. Other areas of use must be released by KERN in writing.

3.3 Warranty

Warranty claims shall be voided in case

- Our conditions in the operation manual are ignored
- The appliance is used outside the described uses
- The appliance is modified or opened
- Mechanical damage or damage by media, liquids, natural wear and tear
- The appliance is improperly set up or incorrectly electrically connected
- The measuring system is overloaded

3.4 Monitoring of Test Resources

In the framework of quality assurance the measuring-related properties of the display unit and, if applicable, the testing weight, must be checked regularly. The responsible user must define a suitable interval as well as type and scope of this test. Information is available on KERN's home page (www.kern-sohn.com) with regard to the monitoring of display units' test substances and the test weights required for this. In KERN's accredited DKD calibration laboratory test weights and display units may be calibrated (return to the national standard) fast and at moderate cost.

4 Basic Safety Precautions

4.1 Pay attention to the instructions in the Operation Manual

Carefully read this operation manual before setup and commissioning, even if you are already familiar with KERN balances.

4.2 Personnel training

The appliance may only be operated and maintained by trained personnel.

5 Transport and storage

5.1 Testing upon acceptance

When receiving the appliance, please check packaging immediately, and the appliance itself when unpacking for possible visible damage.

5.2 Packaging / return transport



- ⇒ Keep all parts of the original packaging for a possibly required return.
- ⇒ Only use original packaging for returning.
- ⇒ Prior to dispatch disconnect all cables and remove loose/mobile parts.
- ⇒ Reattach possibly supplied transport securing devices.
- ⇒ Secure all parts such as the glass wind screen, the weighing platform, power unit etc. against shifting and damage.

6 Unpacking and placing

6.1 Installation Site, Location of Use

The display units are designed in a way that reliable weighing results are achieved in common conditions of use.

Precise and fast work is achieved by selecting the right place for your display unit and your weighing plate.

On the installation site observe the following:

- Place the display unit and the weighing plate on a stable, even surface.
- Avoid extreme heat as well as temperature fluctuation caused by installing next to a radiator or in the direct sunlight;
- Protect the display unit and the weighing plate against direct draft from open windows or doors.
- Avoid jarring during weighing;
- Protect the display unit and the weighing plate against high humidity, vapours and dust.
- Do not expose the display unit to extreme dampness for longer periods of time. Non-permitted condensation (condensation of air humidity on the appliance) may occur if a cold appliance is taken to a considerably warmer environment. In this case, acclimatize the disconnected appliance for ca. 2 hours at room temperature.
- Avoid static charge of goods to be weighed or weighing container.

Major display deviations (incorrect weighing results) may be experienced should electromagnetic fields (e.g. due to mobile phones or radio equipment), static electricity accumulations or instable power supply occur. Change location or remove source of interference.

6.2 Unpacking and placing

Take the display unit carefully out of its packaging, remove the plastic jacket and install it at the designated work space.

Mount the display unit in a way that facilitates operation and where it is easy to see.

6.3 Scope of delivery / serial accessories:

- Display Unit
- Mains adapter
- Support base incl. wall bracket
- Operating instructions

6.4 Transportation lock (illustration example)

Please note: if the display unit is used together with platform with transportation lock, this transportation lock must be released prior to use:

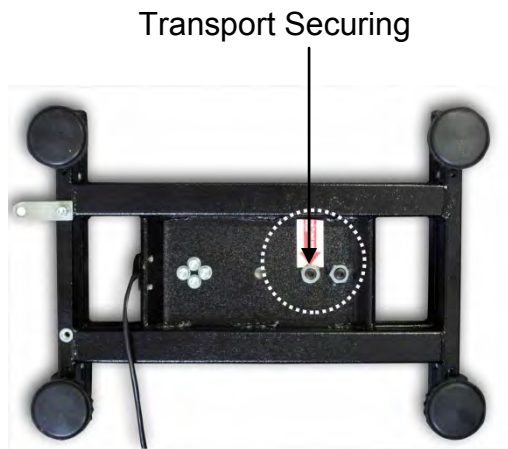

6.5 Error message



As soon as an error message appears in the balance display, the balance must not more be used, e.g. Err 4

6.6 Mains connection

Power is supplied via the external mains adapter. The stated voltage value must be the same as the local voltage.

Only use original KERN mains adapters. Using other makes requires consent by KERN.

6.7 Storage battery operation (optional)

Before the first use, the battery should be charged by connecting it to the mains power supply for at least 12 hours.

If the weight display shows , this is an indication that the capacity of the rechargeable battery is almost exhausted. The unit will be ready for operation for approx. another 10 hours before switching off automatically. Charge the battery with the help of the supplied power pack.

The LED display informs you during loading about the loading status of the rechargeable battery.

red: Voltage has dropped below prescribed minimum.

green: Battery is completely discharged

yellow: Charging storage battery

To conserve energy, enable the automatic switch-off function „AUTO OFF“, see chap. 7.14.

6.8 Adjustment















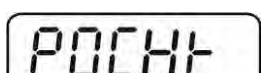

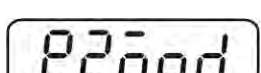

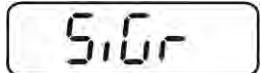
As the acceleration value due to gravity is not the same at every location on earth, each display unit with connected weighing plate must be coordinated - in compliance with the underlying physical weighing principle - to the existing acceleration due to gravity at its place of location (only if the weighing system has not already been adjusted to the location in the factory). This adjustment process must be carried out for the first commissioning, after each change of location as well as in case of fluctuating environment temperature. To receive accurate measuring values it is also recommended to adjust the display unit periodically in weighing operation.

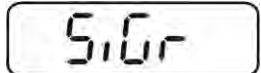
i	<ul style="list-style-type: none">• In weighing systems with a resolution of $< 15\,000$ dividing steps an adjustment is recommended. In weighing systems with a resolution of $> 15\,000$ dividing steps a linearisation is recommended (see chap. 6.10).• Prepare the required adjustment weight. The weight to be used depends on the capacity of the scale. Carry out adjustment as near as possible to the scale's maximum weight. Info about test weights can be found on the Internet at: http://www.kern-sohn.com.• Observe stable environmental conditions. Stabilisation requires a certain warm-up time.•
----------	--







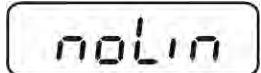

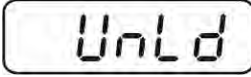

6.8.1 Verified weighing systems

i	<p>In verified weighing systems the menu item for adjustment „P2 mode“ is blocked.</p> <p>KERN KFB-TAM</p> <p>To disable the access lock, destroy the seal and actuate the adjustment switch. Position of the adjustment switch see chap. 6.11</p> <p>KERN KFN-TAM</p> <p>To override the blocked access you will have to destroy the seal before calling up the menu and to short-circuit the two contacts on the circuit board [K2], using a jumper (See chap. 6.11).</p> <p>Attention: After destruction of the seal the weighing system must be re-verified by an authorised agency and a new verification wire/seal mark fitted before it can be reused for applications subject to verification.</p>
----------	--

Call up menu:

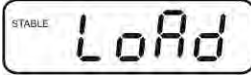









1. Switch-on balance and during the selftest press  .	
2. Press  ,  ,  subsequently, the first menu block „PO CHK“ will be displayed.	
3. Press  repeatedly until „P2 mode“ will be displayed. For the KFB-TAM model operate the adjustment switch.	
4. Press  and select the set weighing scales type by  .  = Single-range balance  = Dual range balance  = Multi-interval balance	 ⇕  ⇕ 
5. Acknowledge with  .	
6. Press  repeatedly until „CAL“ will be displayed.	
7. Confirm with  and select setting „noLin“ by  .	

How to carry out an adjustment:

<p>⇒ Confirm menu setting „noLin“ by . Ensure that there are no objects on the weighing plate.</p>	 ↓ 
<p>⇒ Wait for stability display, then press .</p>	
<p>⇒ The currently set adjustment weight will be displayed.</p>	
<p>⇒ To change by using the navigation buttons (see chap. 2.1.1) select the desired setting, the active digit is flashing. ⇒ Acknowledge with .</p>	
<p>⇒ Carefully place adjusting weight in the centre of the weighing plate. Wait for stability display, then press .</p>	
<p>⇒ After the adjustment the balance will carry out a self-test. Remove adjusting weight during selftest, balance will return into weighing mode automatically. An adjusting error or incorrect adjusting weight will be indicated by the error message; repeat adjustment procedure.</p>	

6.8.2 Non verifiable weighing systems

Call up menu:

1. Switch-on balance and during the selftest press .
 2. Press subsequently , ,  the first menu block „PO CHK“ will be displayed.
 3. Press  repeatedly until „P3 CAL“ will be displayed.
 4. Confirm with ; press  repeatedly until „CAL“ appears.
 5. Acknowledge using , the current setting is displayed.
- ⇒ Press  to confirm; press  to select setting.
 noLin = adjustment
 LineAr = linearization, see chap. 6.10

Pn

POCHK

P3CAL





CAL

noLin



LineAr

How to carry out adjustment:

- ⇒ Confirm menu setting „noLin“ by .
 Ensure that there are no objects on the weighing plate.
- ⇒ Wait for stability display, then press .
- ⇒ The currently set adjustment weight will be displayed.
- ⇒ To change by using the navigation buttons (see chap. 2.1.1) select the desired setting, the active digit is flashing.
- ⇒ Acknowledge with .
- ⇒ Carefully place adjusting weight in the centre of the weighing plate. Wait for stability display, then press .
- ⇒ After the adjustment the balance will carry out a self-test. Remove adjusting weight **during** selftest, balance will return into weighing mode automatically. An adjusting error or incorrect adjusting weight will be indicated by the error message; repeat adjustment procedure.

noLin



UnLd

STABLE UnLd

30000 kg

STABLE LoAd

PASS

STABLE
 ERROR
 UNDER 0.0000 kg

6.9 Linearization

Linearity shows the greatest deviation of a weight display on the scale to the value of the respective test weight according to plus and minus over the entire weighing range. If linearity deviation is discovered during a testing instrument control, you can improve this by means of linearization.



- In balances with a resolution of > 15 000 dividing steps carrying out a linearisation is recommended.
- Carrying out linearization is restricted to specialist staff possessing well acquainted with the workings of weighing scales.
- The test weights to be used must be adapted to the weighing scale's specifications; see chapter "testing instruments control".
- Observe stable environmental conditions. Stabilisation requires a certain warm-up time.
- After successful linearisation you will have to carry out calibration; see chapter "testing instruments control".
- The adjustment is locked for verified balances. To disable the access lock, destroy the seal and actuate the adjustment switch. Position of the adjustment switch see chap. 6.11

6.9.1 Verified weighing systems:

⇒ Menu item P2 mode ⇒ Cal ⇒ Call up liner, see chap. 6.9.1

⇒ Confirm by , the password query „Pn“ will be displayed.

⇒ Press subsequently , ,  or , , . Ensure that there are no objects on the weighing pan.

⇒ Wait for stability display, then press .

⇒ When "Ld 1" is displayed, put the first adjustment weight (1/3 max) carefully in the centre of the weighing platform. Wait for stability display, then press .

⇒ When "Ld 2" is displayed, put the second adjustment weight (2/3 max) carefully in the centre of the weighing platform.

Wait for stability display, then press .

⇒ When "Ld 3" is displayed, put the third adjustment weight (max) carefully in the centre of the weighing platform. Wait for stability display, then press .

- ⇒ After linearisation the balance will carry out a self-test. Remove adjusting weight **during** selftest, balance will return into weighing mode automatically.







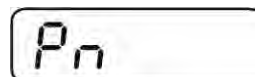

6.9.2 Non-verified weighing systems

- ⇒ Call-up menu item P3 CAL⇒Cal⇒Liner, see chap. 6.9.1



- ⇒ Confirm by , the password query „Pn“ will be displayed.



- ⇒ Press , ,  or , ,  subsequently. Ensure that there are no objects on the weighing pan.



- ⇒ Wait for stability display, then press .



- ⇒ When “Ld 1“ is displayed, put the first adjustment weight (1/3 max) carefully in the centre of the weighing platform. Wait for stability display, then press .





- ⇒ When “Ld 2“ is displayed, put the second adjustment weight (2/3 max) carefully in the centre of the weighing platform.

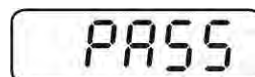

Wait for stability display, then press .

- ⇒ When “Ld 3“ is displayed, put the third adjustment weight (max) carefully in the centre of the weighing platform. Wait



for stability display, then press .

- ⇒ After a successful linearisation the balance will carry out a self-test. Remove adjusting weight **during** selftest, balance will return into weighing mode automatically.



6.10 Verification

General introduction:

According to EU directive 90/384/EEC balances must be officially verified if they are used as follows (legally controlled area):

- a) For commercial transactions if the price of goods is determined by weighing.
- b) For the production of medicines in pharmacies as well as for analyses in the medical and pharmaceutical laboratory.
- c) For official purpose.
- d) For manufacturing final packages.

In cases of doubt, please contact your local trade in standard.

Verification notes:

An EU Qualification Approval is in existence for verified weighing systems. If a balance is used where obligation to verify exists as described above, it must be verified and re-verified at regular intervals.

Reverification is carried out according to the relevant national statutory regulations.

The validity for verification of balances in Germany is e.g. 2 years.

The legal regulation of the country where the balance is used must be observed!



- Verification of the weighing system is invalid without the "seal".

Notes on verified weighing systems

KFB-TAM:

Access to conductor plate:

- Remove seal
- Open display unit
- The application of the display unit as a weighing system able to be verified requires that the contacts of the circuit board are short-circuited with the help of a jumper [K1].
For non verifiable weighing systems remove the jumper.

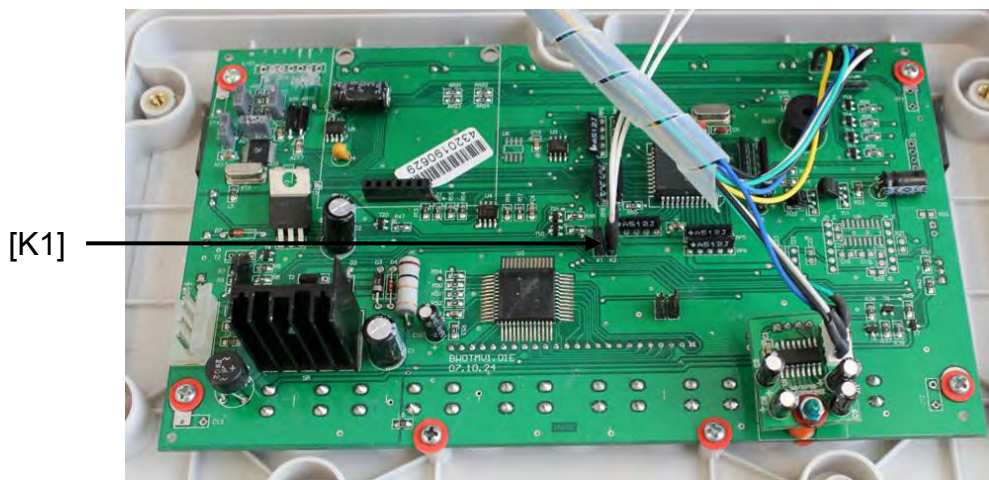

In verified weighing systems the menu item for adjustment, „P2 mode“ will be blocked.

To disable the access lock, destroy the seal and actuate the adjustment switch.

Position of seals and adjusting switch

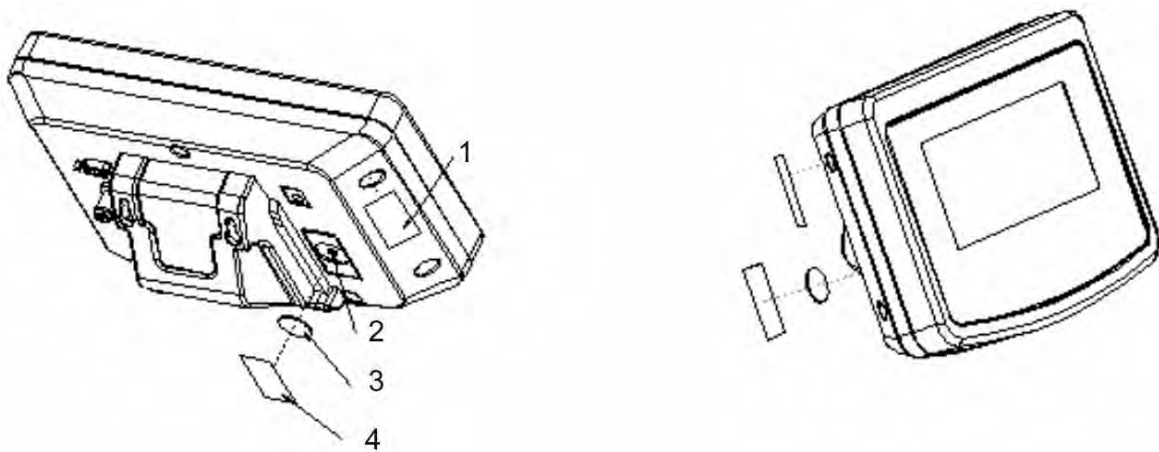

1. Self-destroying seal mark
2. Adjustment switch
3. Cover of adjustment switch
4. Self-destroying seal mark

KFN-TAM:

Access to conductor plate:

- Remove seal
- Open display unit
- The application of the display unit as a weighing system able to be verified requires that the contacts of the circuit board are short-circuited with the help of a jumper [K1]. For non verifiable weighing systems remove the jumper.
- To adjust, short-circuit the contacts of the circuit board, using a jumper [K2].

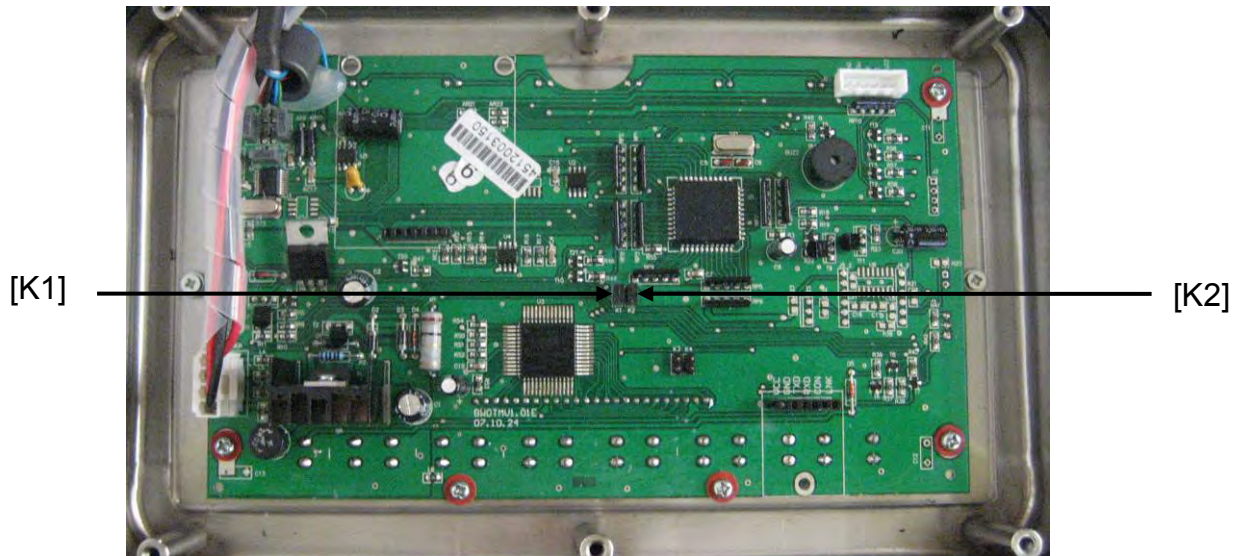

7 Operation

7.1 Start-up

- ⇒ Press  and the instrument will carry out a self-test. As soon as the weight display appears, the instrument will be ready to weigh.



7.2 Switching Off

- ⇒ Press  and the display will disappear.

7.3 Zeroing

Resetting to zero corrects the influence of light soiling on the weighing plate. The unit is equipped with an automatic zero setting function. Therefore the unit can be reset to zero at any time as follows:

- ⇒ To unload the weighing system

- ⇒ Press  and zero display as well as indicator **ZERO** will appear.



7.4 Simple weighing

- ⇒ Place goods to be weighed on balance.
⇒ Wait until stability display **STABLE** appears.
⇒ Read weighing result.



Overload warning

Overloading exceeding the stated maximum load (max) of the device, minus a possibly existing tare load, must be strictly avoided. This could damage the instrument.

Exceeding maximum load is indicated by the display of „----“ and an audio sound. Unload weighing system or reduce preload.

7.5 Switch-over weighing unit (only not verifiable weighing systems)

How to enable weighing units:

⇒ Call-up menu item **P5 Unt**, see chap. 8.1

P5Unt

⇒ Press  and the first weighing unit with the current setting will be displayed.

on^{kg}

⇒ To enable [on] / disable [off] the displayed weighing unit, press .

⇕
off^{kg}

⇒ Acknowledge with . The next unit with the current setting will be displayed.

on^{lb}

⇒ To enable [off] / disable [on] the displayed weighing unit, press .

⇒ Acknowledge with .

⇒ Repeat sequence for each weighing unit.

Note:

„tj“ and „Hj“ cannot be activated at the same time, only either ... or ...

⇒ Return to weighing mode using .

STABLE
ZERO
MODE
0.000^{kg}

Switch-over weighing unit:

⇒  Keep pressed, the display changes over to the weighing units activated before (e.g. kg ⇌ lb)

STABLE
GROSS
1.000^{kg}



⇕
STABLE
GROSS
2.205^{lb}

7.6 Weighing with tare

- ⇒ Deposit weighing vessel. After successful standstill control press the  button. Zero display and indicator **NET** appear.



The weight of the container is now internally saved.

- ⇒ Weigh the material, the net weight will be indicated.
- ⇒ The weight of the weighing container will be displayed as a minus number after removing the weighing container.
- ⇒ The tare procedure can be repeated as many times as necessary, for example with initial weighing of several components for a mix (add-on weighing). The limit is reached when the taring range capacity (see type plate) is full.
- ⇒ To change between gross weight and net weight, press .
- ⇒ To delete the tare value, remove load from weighing plate and press .

7.7 Weighing with tolerance range

You can set an upper or lower limit when weighing with tolerance range and thus ensure that the weighed load remains exactly within the set limits.

During tolerance tests such as dosing, portioning and sorting the unit will indicate exceeded or undershot limits by emitting an optical or acoustic signal.

Audio signal:

The acoustic signal depends on the settings in menu block „BEEP“.

Options:

- no Acoustic signal turned off
- ok An acoustic signal sounds when load is within tolerance limits
- ng An acoustic signal sounds when load is beyond tolerance limits

Optical signal:

Three colour signal lights indicate whether the load is within the two tolerance limits.

The signal lights provide the following information:

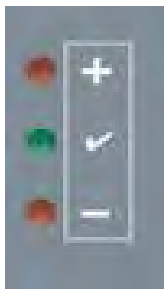

	+	Goods to be weighed above tolerance limit	Red signal light glowing
	✓	Goods to be weighed within tolerance range	Green signal light glowing
	-	Goods to be weighed below tolerance limit	Red signal light glowing

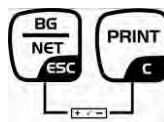
The settings for tolerance weighing may be called up either via menu block „**P0 CHK**“ (see chap. 8) or faster via the key combination



7.7.1 Tolerance check for target weight

Settings

⇒ Press  and  at the same time in weighing mode.

0.000 kg



nEt H

⇒ Press  until the display for entering the lower limit value nEt L appears.

nEt L

⇒ Press , the current setting will be displayed.

100.000 kg

⇒ To enter the lower limit, e. g. 1000 Kg, press the navigation keys (See chap. 2.1.1); the currently enabled digit will be flashing.

10 1.000 kg

⇒ Confirm input by .

nEt L

⇒ Press  repeatedly until nEt H is displayed.

nEt H

⇒ Press , the current setting for the upper limit will be displayed.

⇒ Press the navigation keys (See chap. 2.1.1) to enter the upper limit, e.g. 1,100 kg; the currently enabled digit will be flashing.

101.100 kg

⇒ Confirm input by .

nEt H

⇒ Press  repeatedly until bEEP is displayed.

bEEP

⇒ Press  and the current setting for the acoustic signal will be shown.

of

⇒ Select desired setting (no, ok, ng) by .

⇒ Confirm input by .



bEEP

⇒ Press ; weighing system is in tolerance weighing mode. From here evaluation takes place whether the goods to be weighed are within the two tolerance limits.



Weighing with tolerance range



- ⇒ Tare when using a weighing container.
- ⇒ Put on goods to be weighed, tolerance control is started. The signal lights indicate whether the load is within the two set limits.

Load below specified tolerance	Load within specified tolerance	Load exceeds specified tolerance
 <p>Red signal light next to „-“ ON illuminated</p>	 <p>Green signal light next to „✓“ illuminated</p>	 <p>Red signal light next to „+“ ON illuminated</p>

- i**
- The tolerance control is not active when the weight is under 20d.
 - To delete limits, enter “00.000 kg”.

7.7.2 Tolerance check for target quantity

Settings

⇒ Press  and  at the same time in weighing mode.

0.000 kg



nEt H

⇒ Press  until the display for entering the lower limit value *PCSL* appears.

PCSL

⇒ Press , the current setting will be displayed.

100000^{PCS}

⇒ To enter the lower limit, e. g. 75 items, press the navigation buttons (see chap. 2.1.1); the currently enabled digit will be flashing.

100075^{PCS}

⇒ Confirm input by .

PCSL

⇒ Press  repeatedly until *PCSH* is displayed.

PCSH

⇒ Press , the current setting for the upper limit will be displayed.

100000^{PCS}

⇒ To enter the upper limit, e. g. 100 items, press the navigation buttons (see chap. 2.1.1); the currently enabled digit will be flashing.

100 100^{PCS}

⇒ Confirm input by .

PCSH

⇒ Press  repeatedly until *bEEP* is displayed.

bEEP

⇒  Press and the current setting for the acoustic signal will be shown.

at

⇒ Select desired setting (no, ok, ng) by .

⇒ Confirm input by .



bEEP

⇒ Press ; weighing system is in tolerance weighing mode. From here evaluation takes place whether the goods to be weighed are within the two tolerance limits.



Weighing with tolerance range

- ⇒ Set item weight, see chap. 7.10.
- ⇒ Tare when using a weighing container.
- ⇒ Put on goods to be weighed, tolerance control is started. The signal lights indicate whether the load is within the two set limits.

Load below specified tolerance	Load within specified tolerance	Load exceeds specified tolerance
 <p>Red signal light next to „-“ ON illuminated</p>	 <p>Green signal light next to „✓“ illuminated</p>	 <p>Red signal light next to „+“ ON illuminated</p>

<p>i</p>	<ul style="list-style-type: none"> • The tolerance control is not active when the weight is under 20d. • To delete limits, enter „00000 PCS“.
-----------------	---

7.8 Manual totalizing

With this function the individual weighing values are added into the summation memory by pressing  and edited, when an optional printer is connected.

- i** • Menu setting:
„P1 COM“ or „P2 COM“ ⇨ „MODE“ ⇨ „PR2““, see chap. 8
- The totalizing function is not active when the weight is under 20d.

Add up:

⇒ Place weighing goods A.

Wait until the stability display **STABLE** appears, then press . The weight value will be saved and printed if an optional printer is connected.



⇒ Remove the weighed good. More weighed goods can only be added when the display \leq zero.



⇒ Place goods to be weighed B.

Wait until the stability display appears, then press . Weighing value will be added to summation memory and possibly printed.
The number of weighing actions, followed by the total weight will be displayed for 2 sec.





⇒ Add more weighed goods as described before.



Please note that the weighing system must be unloaded between the individual weighing procedures.

⇒ This process may be repeated 99 times or till such time as the capacity of the weighing system has been exhausted.

Display and output sum „Total“:

⇒ Press , number of weighing, followed by the total weight will be displayed for 2 sec. Press  to print out this display.

Delete weighing data:

⇒ Press  and  at the same time The data in the summation memory are deleted.



Printout example KERN YKB-01N:

Menu setting „P1 COM“ or „P2 COM“ ⇒ „Lab 2“ / Prt 7“

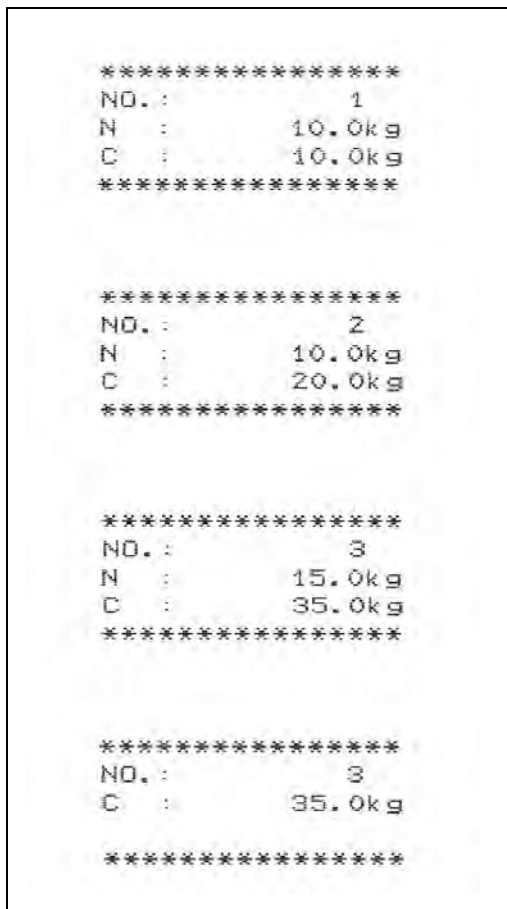

First weighing



Second weighing



Third weighing



A Number of weighings / total e



i Additional printout example see chap. 10.2

7.9 Automatic adding-up

With this function the individual weighing values are automatically added into the summation memory when the balance is unloaded without pressing  and edited, when an optional printer is connected.



- Menu settings:
„P1 COM“ or „P2 COM“ ⇒ „MODE“ ⇒ „AUTO“, see chap. 8
Der Indikator **AUTO** wird angezeigt.



Add up:

- ⇒ Place weighing goods A.

After the standstill control sounds a signal tone. The weighing value will be added to the summation memory and printed.



- ⇒ Remove the weighed good. More weighed goods can only be added when the display \leq zero.

- ⇒ Place goods to be weighed B.

After the standstill control sounds a signal tone. The weighing value will be added to the summation memory and printed. Number of weighing, followed by the total weight will be displayed for 2 sec.

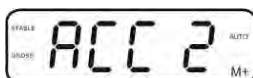

- ⇒ Add more weighed goods as described before.
Please note that the weighing system must be unloaded between the individual weighing procedures.
- ⇒ This process may be repeated 99 times or till such time as the capacity of the weighing system has been exhausted.



Display and delete the weighing data, as well as printout examples see chap. 7.8.

7.10 Parts counting

Before the balance can count parts, it must know the average part weight (i.e. reference). Proceed by putting on a certain number of the parts to be counted. The balance determines the total weight and divides it by the number of parts, the so-called reference quantity. Counting is then carried out on the basis of the calculated average piece weight.

As a rule:

The higher the reference quantity the higher the counting exactness.

⇒ In weighing mode , press and hold until the message „P 10“ appears that is used to set the reference quantity.



STABLE
ZERO
GROSS 0.0000 kg

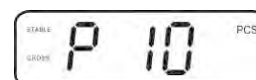

STABLE P 10 PCS
GROSS

⇒ Use  to set the desired reference quantity (such as 100), options include P 10, P 20, P 50, P100, P 200.

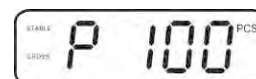

STABLE P 100 PCS
GROSS

⇒ Place as many items to be counted (such as 100 items) as demanded by the set reference quantity and confirm by . The weighing scales calculate the reference weight. The current quantity (such as 100 items) will be displayed.

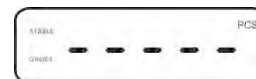

STABLE - - - - PCS
GROSS

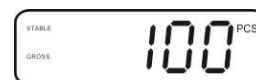

STABLE 100 PCS
GROSS

⇒ Remove reference weight. The balance is from now in parts counting mode counting all units on the weighing plate.



STABLE 0 PCS
ZERO
GROSS

⇒ Back to Weighing mode by  .



STABLE
ZERO
GROSS 0.0000 kg

7.11 Animal weighing

The animal weighing function is suitable for weighing restless loads.

The weighing system will display a mean value derived from several weighing results.

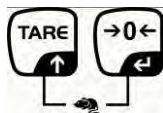

The animal weighing program can be enabled by either calling up menu block „P3 OTH“ or „P4 OTH“ ⇒ „ANM“ ⇒ „ON“ (See chap. 8) or faster via key combination.



The indicator shows HOLD as long as the animal weighing function remains enabled.



⇒ Place the load on the weighing system and wait until the scale is steady.

⇒ Press  and  at the same time; you will hear an acoustic signal, indicating that the animal weighing function is enabled. Whilst averaging is taking place you can add or remove loads as the measuring value will be constantly updated.

⇒ To deactivate the animal weighing function press  and  at the same time.

7.12 Lock keyboard

To enable/disable the keyboard lock go to menu item „P3 OTH“ or „P4 OTH“ ⇒ „**LOCK**“, see chap.8.

Whilst the function is enabled the keyboard will self-lock after no key has been pressed for 10 minutes. „**K-LCK**“ will be displayed as soon as a key is pressed.

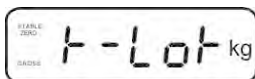

To disable the lock, press ,  and  hold plus (2 s) until „**U LCK**“ appears.

7.13 Display background illumination

⇒ Keep  pressed (3s) until „**setbl**“ appears.

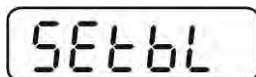

⇒ Press  again, the current setting will be displayed.

⇒ Use  to select the desired setting.

bl on Continuous background lighting

bl off Background illumination off

bl Auto Automatic background illumination on when weighing plate is loaded or key pressed.

⇒ Either save by  or cancel by pressing .

Back to weighing mode by .

7.14 Automatic switch-off function „AUTO OFF“

The unit is automatically switched off within the preset time when the display unit or the weighing bridge are not operated.

⇒ Keep  pressed (3s) until „setbl“ appears.

SETbl

⇒ Press  to call up AUTO OFF-function

SETof

⇒ Press , the current setting will be displayed.

⇒ Use  to select the desired setting.

of 0 AUTO OFF - function disabled

of 3 Weighing system will be turned off after 3 min.

of 5 Weighing system will be turned off after 5 min.

of 15 Weighing system will be turned off after 15 min.

of 30 Weighing system will be turned off after 30 min.









⇒ Either save by  or cancel by pressing .

Back to weighing mode by .



8 Menu

The application of the display unit as a verified weighing system requires that you short-circuit the two contacts [K1] of the circuit board, using a jumper. To that effect, a menu for verified weighing systems is available. For menu layout see chap. 8.2. There is no jumper for weighing systems that cannot be verified. To that effect, a menu is available for weighing systems that cannot be verified, Menu layout see chap. 8.1

Navigation in the menu:

Call up menu	<p>⇒ Switch-on balance and during the selftest press  .</p> <div style="text-align: center; border: 1px solid black; padding: 5px; width: fit-content; margin: 10px auto;">Pn</div> <p>⇒ Press , ,  subsequently, the first menu block „PO CHK“ will be displayed.</p> <div style="text-align: center; border: 1px solid black; padding: 5px; width: fit-content; margin: 10px auto;">POCHK</div>
Select menu block	<p>⇒ With help of  , the individual menu items can be selected one after the other.</p>
Select setting	<p>⇒ Confirm selected menu item by pressing  . The current setting will be displayed.</p>
Change settings	<p>⇒ To change to the available settings, press the navigations keys as described in chap. 2.1.</p>
Acknowledge setting / exit the menu	<p>⇒ Either save by pressing  or cancel by pressing  .</p>
Return to weighing mode	<p>⇒ Press  repeatedly to exit menu.</p>

8.1 Overview non verifiable weighing systems (contacts of circuit board [K1] not short-circuited)

Menu block Main menu	Menu item Submenu	Available settings / explanation		
PO CHK Weighing with tolerance range, see chap. 7.7	nEt H	Upper limit value „Tolerance check weighing“, input see chap. 7.7.1		
	nEt LO	Lower limit value „Tolerance check weighing“, input see chap. 7.7.1		
	PCS H	Upper limit value „Tolerance check counting“, input see chap. 7.7.2		
	PCS L	Lower limit value „Tolerance check counting“, input see chap. 7.7.2		
	BEEP	no	Acoustic signal for weighing with tolerance range switched off	
		ok	Audio sound when load is within tolerance limits	
		nG	Audio sound when load is beyond tolerance limits	
P1 REF Zero point settings	A2n0	Automatic zero point correction (Autozero) by changing the display, digits selectable (0.5d, 1d, 2d, 4d)		
	0AUto	Zero setting range Load range where the display after switching-on the balance is set to zero. Selectable 0, 2, 5, 10, 20, 30, 50, 100 %		
	0rAGE	Zero setting range Load range where the display is set to zero by pressing  . Selectable 0, 2, 4, 10, 20*, 50, 100%.		
	0tArE	Automatic taring „on / off“, taring range adjustable in menu item „0Auto“.		
	SPEED	Not documented		
	Zero	Zero point setting		
	P2 COM Interface parameter	MODE	CONT	S0 off S0 on
ST1			One output for stable weighing value	
STC		Continuous data output of stable weighing values		
PR1		Output after pressing 		
PR2		Manual totalizing, see chap. 7.8.		
		Press  and the weighing value will be added to the summation memory and issued.		

		AUTO*	For automatic add-up see chap. 7.9. This function is used to issue and add individual weighing values automatically to the summation memory on unloading of weighing scale.		
		ASK	For remote control commands, see chap. 10.4		
		wirel	Not documented		
		BAUD	Available Baudrate: 600, 1200, 2400, 4800, 9600*		
		Pr	7E1	7 bits, even parity	
			7o1	7 bits, odd parity	
			8n1*	8 bits, no parity	
		PTYPE	tPUP*	Standard printer setting	
			LP50	Not documented	
		Lab	Lab x	For data output format, see chap.8.2, tab. 1 (Factory settings LAb 2 / Prt 7)	
		Prt	Prt x		
		LAnG	eng*	Standard settings English	
			chn		
P3 CAL Configuration data see chap. 12.4	COUNT	Display internal resolution			
	DECI	Position of the decimal dot			
	DUAL	Setting balance type, capacity (Max) and readability (d)			
		off	Single-range balance		
			R1 inc	Readability	
			R1 cap	Capacity	
		on	Dual range balance		
			R1 inc	Readability 1st weighing range	
			R1 cap	Capacity 1st weighing range	
					
	R2 inc		Readability 2nd weighing range		
R2 cap	Capacity 2nd weighing range				
CAL	noLin	For adjustment, see chap. 6.9.2			
	Liner	For linearization, see chap. 6.10.2			
GrA	Not documented				
P4 OTH	LOCK	on	Keyboard lock enabled, see chap. 7.11		
		off*	Keyboard lock disabled		
	ANM	on	Animal weighing enabled, see chap. 7.10		
		off*	Animal weighing disabled		

P5 Unt Switch-over weighing unit, see chap. 7.5	kg	on*	
		off	
	g	on	
		off*	
	lb	on	
		off*	
	oz	on	
		off*	
	tJ	on	
		off	
	HJ	on	
		off	
P6 xcl		Not documented	
P7 rst		Use  to reset balance settings to factory default.	
P8 uwb		Not documented	
P9 Ckm	CK nt	Not documented	
	CK P5		
	CK of		

Factory settings are marked by *.

8.2 Overview verified weighing systems (contacts of circuit board [K1] short-circuited by means of jumper)

In verified weighing systems the access to „P2 mode and „P4 tAr“ is locked.

KERN KFB-TAM:



To disable the access lock, destroy the seal and actuate the adjustment switch.
Position of the adjustment switch see chap. 6.11.

KERN KFN-TAM:



In order to unlock the access, the seal must be destroyed and both contacts of the printed circuit board [K2] must be short-circuited by a jumper, see chap. 6.11.

Attention:

After destruction of the seal the weighing system must be re-verified by an authorised agency and a new verification wire/seal mark fitted before it can be reused for applications subject to verification.

Menu block Main menu	Menu item Submenu	Available settings / explanation		
PO CHK Weighing with tolerance range, see chap. 7.7	nEt H	Upper limit value „Tolerance check weighing“, input see chap. 7.7.1		
	nEt LO	Lower limit value „Tolerance check weighing“, input see chap. 7.7.1		
	PCS H	Upper limit value „Tolerance check counting“, input see chap. 7.7.2		
	PCS L	Lower limit value „Tolerance check counting“, input see chap. 7.7.2		
	BEEP	no	Acoustic signal for weighing with tolerance range switched off	
		ok	Audio sound when load is within tolerance limits	
		ng	Audio sound when load is beyond tolerance limits	
P1 COM Interface parameter	MODE	CONT	S0 off Continuous data output, S0 on selectable “send zero” yes / no	
		ST1	One output for stable weighing value	
	STC	Continuous data output of stable weighing values		
	PR1	Output after pressing 		
	PR2	Manual totalizing, see chap. 7.8 Press  and the weighing value will be added to the summation memory and issued.		
	AUTO	For automatic totalizing see chap. 7.9 This function is used to issue and add individual weighing values automatically to the summation memory on unloading of weighing scale.		

		ASK	For remote control commands, see chap. 10.4		
		wireless	Not documented		
	baud	Available Baudrate: 600, 1200, 2400, 4800, 9600			
	Pr	7E1	7 bits, even parity		
		7o1	7 bits, odd parity		
		8n1	8 bits, no parity		
	PtYPE	tPUP	Standard printer setting		
		LP50	Not documented		
	Lab	Lab x	Details see following table 1 (Factory settings LAb 2 / Prt 7)		
	Prt	Prt x			
Lang	Eng*	Standard setting English			
	Chn				
P2 mode Konfigurations- daten	SiGr	Single-range balance			
		COUNT	Display internal resolution		
		DECI	Position of the decimal dot		
		Div.	Readability [d] / verification value[s]		
		CAP	Balance capacity [Max]		
		CAL	noLin	Adjustment, see chap. 6.9	
			LinEr	Linearisation, see chap. 6.10	
		GrA	Not documented		
	dUAL 1	Dual range balance			
		Balance with two weighing ranges and different maximum load and weighing ranges and interval sizes but only one load-supporting pan, whereby each range extends from zero to the respective maximum capacity. When load is removed, weighing scales will remain in 2nd range.			
		COUNT	Display internal resolution		
		DECI	Position of the decimal dot		
		div.	div 1	Readability [d] / verification value [e] 1. weighing range	
			div 2	Readability [d] / verification value [e] 2. weighing range	
		CAP	CAP 1	Weighing scale capacity [max] 1. Weighing range	
			CAP 2	Weighing scale capacity [max] 2. Weighing range	
		CAL	noLin	Adjustment, see chap. 6.9	
			LinEr	For linearization, see chap. 6.10	
	GrA	Not documented			

	dUAL 2	Multi-interval balance Weighing scales with one weighing range subdivided into partial weighing ranges, each providing a different scale interval. The scale interval depends on the applied load and is automatically changed during loading and unloading.	
		COUNT	Display internal resolution
		DECI	Position of the decimal dot
		div.	div 1 Readability [d] / verification value [e] 1. weighing range
			div 2 Readability [d] / verification value [e] 2. weighing range
		CAP	CAP 1 Weighing scale capacity [max] 1. Weighing range
			CAP 2 Weighing scale capacity [max] 2. Weighing range
		CAL	noLin Adjustment, see chap. 0
			LinEr Linearisation, see chap. 6.10
		GrA	Not documented
P3 OTH s. Kap. 7.10 / 7.11	LOCK	on	Keyboard lock enabled
		off	Keyboard lock disabled
	ANM	on	Animal weighing enabled
		off	Animal weighing disabled
P4 tAr Restricted taring range		Press  , the current setting will be displayed. Using the navigation buttons (see chap. 2.1.1) select the desired setting, the active digit is flashing. Confirm input by  .	
P5 St Follow up tare	St on	Follow up tare switched on	
	St off	Follow up tare switched off	
P6 SP	7.5, 15, 30	Not documented	

Tab. 1.: Printout examples

- Menu setting P1 Com / P2 Com ➔ Mode ➔ PR2

- Data output 

Lab Prt	0	1	2	3
0~3	<p>*****</p> <p>GS: 5.000kg</p> <p>*****</p>	<p>*****</p> <p>NT: 5.000kg TW: 5.000kg GW: 10.000kg</p> <p>*****</p>	<p>*****</p> <p>GS: 5.000kg TOTAL: 10.000kg</p> <p>*****</p>	<p>*****</p> <p>NT: 5.000kg TW: 5.000kg GW: 10.000kg TOTAL: 10.000kg</p> <p>*****</p>
4~7	<p>*****</p> <p>No.: 1 GS: 5.000kg</p> <p>*****</p>	<p>*****</p> <p>No.: 1 NT: 5.000kg TW: 5.000kg GW: 10.000kg</p> <p>*****</p>	<p>*****</p> <p>No.: 1 GS: 5.000kg TOTAL: 10.000kg</p> <p>*****</p>	<p>*****</p> <p>No.: 1 NT: 5.000kg TW: 5.000kg GW: 10.000kg TOTAL: 10.000kg</p> <p>*****</p>

G	Gross weight
N	Net weight
T	Tare weight
NO	Number weighing processes
C	Total of all individual weighings

9 Service, maintenance, disposal

9.1 Clean

- Before cleaning, disconnect the appliance from the operating voltage.
- Do not use aggressive detergents (solvents or similar).

9.2 Service, maintenance

The appliance may only be opened by trained service technicians who are authorized by KERN.

Before opening, disconnect from power supply.

9.3 Disposal

Disposal of packaging and appliance must be carried out by operator according to valid national or regional law of the location where the appliance is used.

9.4 Error messages

Error message	Description	Possible causes
- - - - -	Maximum load exceeded	<ul style="list-style-type: none"> • Unload weighing system or reduce preload.
- - ol - -		
Err 1	Incorrect data input	<ul style="list-style-type: none"> • Follow format "yy:mm:dd"
Err 2	Incorrect time entry	<ul style="list-style-type: none"> • Follow format "hh:mm:ss"
Err 4	Zeroing range exceeded due to switching-on balance or pressing  (normally 4% max)	<ul style="list-style-type: none"> • Object on the weighing plate • Overload when zeroing
Err 5	Keyboard error	
Err 6	Value outside the A/D changer range	<ul style="list-style-type: none"> • Weighing plate not installed • Damaged weighing cell • Damaged electronics
Err 9	Stability display does not appear	<ul style="list-style-type: none"> • Check the environmental conditions.

Err 10	Communication error	<ul style="list-style-type: none"> No data
Err 15	Gravitation error	<ul style="list-style-type: none"> Range 0.9 ~ 1.0
Err 17	Taring range exceeded	<ul style="list-style-type: none"> Reduce load
Err 19	Zero point displaced	<ul style="list-style-type: none"> Remedy: Adjust / linearize
Fai I h / Fai I l	Adjustment error	<ul style="list-style-type: none"> Repeat adjustment.
Err P	Printer error	<ul style="list-style-type: none"> Check communication parameters
Ba lo / Lo ba	Battery very low	<ul style="list-style-type: none"> Recharge battery

Should other error messages occur, switch balance off and then on again. If the error message remains inform manufacturer.

10 Data output RS 232C

You can print weighing data automatically via the RS 232C interface or manually by pressing  via the interface according to the setting in the menu.

This data exchange is asynchronous using ASCII - Code.

The following conditions must be met to provide successful communication between the weighing system and the printer.

- Use a suitable cable to connect the display unit to the interface of the printer. Faultless operation requires an adequate KERN interface cable.
- Communication parameters (baud rate, bits and parity) of display unit and printer must match. For a detailed description of interface parameters see chap. 8, menu block „P1 COM“ or „P2 COM“

10.1 Technical data

Connection 9 pin d-subminiature bushing

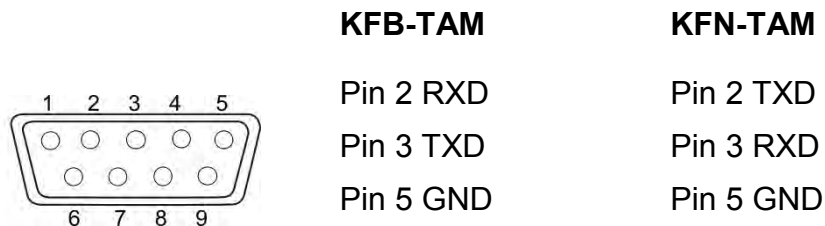

Baud rate Optional 600/1200/2400/4800/9600

Parity 8 bits, no parity / 7 bits, even parity / 7 bits, odd parity

10.2 Printer mode / Printout examples (KERN YKB-01N)

- **Weighing**

1. Continuous output

(Menu setting P1 Com ➔ Mode ➔ Com ➔ S0 on
bzw. P2 Com ➔ Mode ➔ Com ➔ S0 on)

Menu setting P1 Com bzw. P2 Com ➔ LAb 0 / Prt 0:

```
*****
ST, G ,      53,2 kg
*****
```

```
*****
US, G ,      53,2 kg
*****
```

2. Data output 
 (Menu settings: P1 Com ➔ Mode ➔ Pr1 bzw. P2 Com ➔ Mode ➔ Pr1)

Menu setting P1 Com bzw. P2 Com ➔ LAb 0 / Prt 0:

```
*****
G :          53,2 kg
*****
```

```
*****
N :          52,6 kg
*****
```

Menu setting P1 Com bzw. P2 Com ➔ LAb 3 / Prt 7:

```
*****
N :          53,2 kg
T :          0,0 kg
G :          53,2 kg
*****
```

```
*****
N :          52,6 kg
T :          10,0 kg
G :          62,6 kg
*****
```

- Counting

```
*****
PCS          100
*****
```

- **Totalizing**

3. Data output 

(Menu setting P1 Com ➔ Mode ➔ PR2 bzw. P2 Com ➔ Mode ➔ Pr2)

P1 Com bzw. P2 Com ➔ LAb 3/Prt 7:

```

*****
NO. :      1
N  :    54.2kg
T  :    10.0kg
G  :    64.2kg
C  :    54.2kg
*****

*****
NO. :      2
N  :    54.2kg
T  :    10.0kg
G  :    64.2kg
C  :   108.4kg
*****

*****
NO. :      3
N  :    59.2kg
T  :    10.0kg
G  :    69.2kg
C  :   167.6kg
*****

*****
NO. :      3
C  :   167.6kg
*****

```

P1 Com bzw. P2 Com ➔ LAb 0/Prt 0:

```

*****
G  :    10.0kg
*****

*****
G  :    10.0kg
*****

*****
G  :    15.0kg
*****

*****
NO. :      3
C  :    35.0kg
*****

```

Symbols:

ST	Stable value
US	Instable value
G	Gross weight
N	Net weight
T	Tare weight
NO	Number weighing processes
C	Total of all individual weighings
<lf>	Space line

10.3 Output log (continuous output)

- Weighing

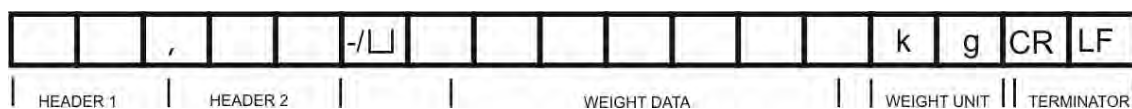

HEADER1: ST=STABLE , US=UNSTABLE

HEADER2: NT=NET , GS=GROSS

10.4 Remote control instructions

Command	Function	Printout examples
S	Stable weighing value for the weight is sent via the RS232 interface	ST,G , 1.000KG
W	Weighing value for the weight (stable or unstable) is sent via the RS232 interface	US,G , 1.342KG
R		ST,G , 1.000KG
T	No data are sent, the balance carries out the tare function.	-
Z	No data are sent, the zero-display appears.	-
P	Quantity will be sent via the RS232-interface	10PCS

10.5 I/O-Function

Models KFB-TAM / KFN-TAM:

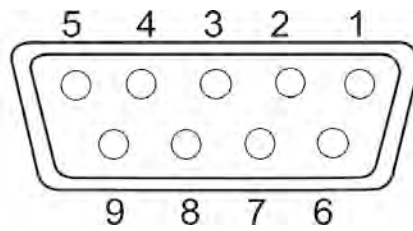

RS232		KFB-TAM	KFN-TAM
	Pin 2	RXD	TXD
	Pin 3	TXD	RXD
	Pin 4	VCC 5V	VCC 5V
	Pin 5	GND	GND

Model KFN-TAM:

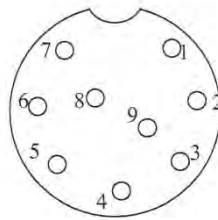

Shift point	Pin 1	VB	
	Pin 5	GND	
	Pin 6	OK	
	Pin 7	LOW	
	Pin 8	HI	
	Pin 9	BEEP	

11 Instant help

In case of an error in the program process, briefly turn off the display unit and disconnect from power supply. The weighing process must then be restarted from the beginning.

Help:

Fault

Possible cause

The displayed weight does not glow.

- The display unit is not switched on.
- Mains power supply interrupted (mains cable defective).
- Power supply interrupted.
- (Rechargeable) batteries are inserted incorrectly or empty
- No (rechargeable) batteries inserted.

The displayed weight is permanently changing

- Draught/air movement
- Table/floor vibrations
- Weighing pan has contact with other objects.
- Electromagnetic fields / static charging (choose different location/switch off interfering device if possible)

The weighing result is obviously incorrect

- The display of the balance is not at zero
- Adjustment is no longer correct.
- Great fluctuations in temperature.
- Warm-up time was ignored.
- Electromagnetic fields / static charging (choose different location/switch off interfering device if possible)

Should other error messages occur, switch display unit off and then on again. If the error message remains inform manufacturer.

12 Installing display unit / weighing bridge

i Installation / configuration of a weighing system must be carried out by a well acquainted specialist with the workings of weighing balances.

12.1 Technical data

Supply voltage:	5 V/150mA
Max. signal voltage	0-10 mV
Zeroing range	0-2 mV
Sensitivity	2-3 mV/V
Resistance parameter	80 - 100 Ω , max 4 items per 350 Ω load cell

12.2 Weighing system design

The display unit is suitable for connection to any analogue platform in compliance with the required specifications.

The following data must be established before selecting a weighing cell:

- **Weighing balance capacity**
This usually corresponds to the heaviest load to be weighed.
- **Preload**
This corresponds to the total weight of all parts that are to be placed on the weighing cell such as upper part of platform, weighing pan etc.
- **Total zero setting range**
This is composed of the start-up zero setting range ($\pm 2\%$) and the zero setting range available to the user via the ZERO-key (2%). The total zero setting range equals therefore 4 % of the scale's capacity.

The addition of weighing scales capacity, preload and the total zero setting range give the required capacity for the weighing cell.

To avoid overloading of the weighing cell, include an additional safety margin.

- **Smallest desired display division**
- **Verifiability, if required**
The application of the display unit as a verified weighing system requires that you short-circuit the two contacts [K1] of the circuit board, using a jumper; for position see chap. 6.11.
Remove the jumper for weighing systems not able to be verified.

12.3 How to connect the platform

- ⇒ Disconnect the display unit from the power supply.
- ⇒ Solder the individual leads of the load cell cable onto the circuit board. See diagrams below.

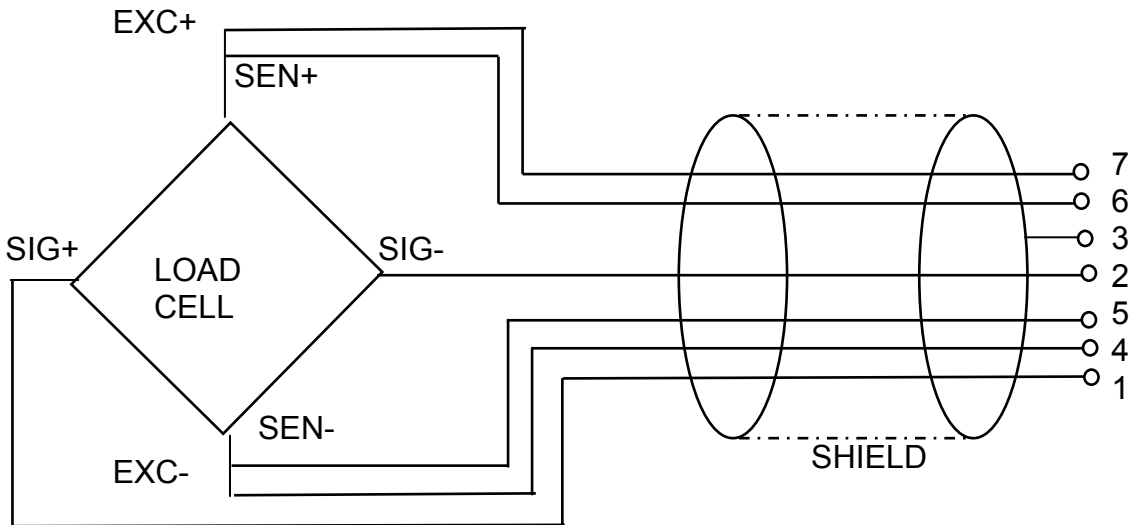

PIN	Loadcell	
	6- conductor	4- conductor
7	EXC+	EXC+
6	SEN+	
5	EXC-	EXC-
4	SEN-	
3	SHIELD	SHIELD
2	SIG-	SIG-
1	SIG+	SIG+

12.4 Configure display unit

12.4.1 Verified weighing systems

(contacts of circuit board [K1] short-circuited by means of jumper)

For menu overview see chap. 8.2.

In verified weighing systems the menu item for calibration „P2 mode“ is blocked.

KERN KFB-TAM:

To disable the access lock, destroy the seal and actuate the adjustment switch.











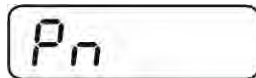

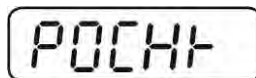

Position of the adjustment switch see chap. 6.11

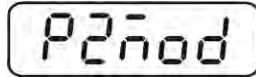

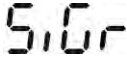

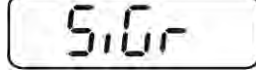

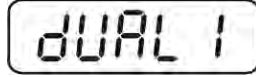













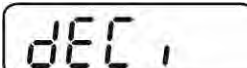

KERN KFN-TAM:

To override the blocked access you will have to destroy the seal before calling up the menu and to short-circuit the two contacts on the circuit board [K2], using a jumper (See chap. 6.11).



Attention:

After destruction of the seal the weighing system must be re-verified by an authorised agency and a new verification wire/seal mark fitted before it can be reused for applications subject to verification.

<p>Call up menu:</p> <p>⇒ Switch-on balance and during the selftest press .</p>	
<p>⇒ Press , ,  subsequently, the first menu block „PO CHK“ will be displayed.</p>	
<p>⇒ Press  repeatedly until „P2 mode“ will be displayed.</p> <p>⇒ Operate the adjustment switch (models KFB-TAM).</p>	
<p>⇒ Press  and use  to select the weighing scales type.</p> <p> Single-range balance</p> <p> Dual range balance</p> <p> Multi-interval balance</p>	    

Example single range scales <i>SiDr</i> (d = 10 g, max. 30 kg)	
<p>⇒ Confirm selected weighing scales type by pressing ; the first menu item „COUNT“ will be shown.</p>	
<p>1. Display internal resolution</p> <p>⇒ Press , the internal resolution will be shown.</p> <p>⇒ Return to menu by .</p> <p>⇒ Press  to select the next menu item.</p>	  
<p>2. Position decimal point</p> <p>⇒ Press , the currently set position of the decimal dot is displayed.</p> <p>⇒ Press  to select the desired setting. Options 0, 0.0, 0.00, 0.000, 0.0000.</p> <p>Confirm input by .</p> <p>⇒ Press  to select the next menu item.</p>	  
<p>3. Readability</p> <p>⇒ Press , and current setting will be displayed.</p> <p>Select desired setting by .</p> <p>Options 1, 2, 5, 10, 20, 50.</p> <p>Confirm entry by .</p> <p>⇒ Press  to select the next menu item.</p>	  

4. Capacity













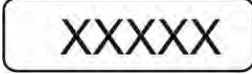

- ⇒ Press , the current setting will be displayed.
Using the navigation buttons (see chap. 2.1.1) select the desired setting, the active digit is flashing.
Confirm input by .

- ⇒ Press  to select the next menu item.

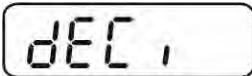
5. Adjustment / linearization

Adjustment or linearization is required after entering configuration data.
For carrying out adjustment see chap. 6.9.1/step 6 or chap. 6.10.1 for linearisation



Example dual range scales <i>dUAL 1</i> (d = 2 / 5 g, max. 6 / 15 kg)	
⇒ Confirm selected weighing scales type by  ; the first menu item „COUNT“ will be shown.	
1. Display internal resolution	
⇒ Press  , the internal resolution will be shown.	
⇒ Return to menu by  .	
⇒ Press  to select the next menu item.	
2. Position decimal point	
⇒ Press  , the currently set position of the decimal dot is displayed.	
⇒ Use  to select the desired setting. Options 0, 0.0, 0.00, 0.000, 0.0000.	
Confirm input by  .	
⇒ Press  to select the next menu item.	

3. Readability

⇒ Press , the display used to enter readability/verification value for first weighing range will appear.

⇒ Press , the current setting will be displayed.

⇒ Select desired setting with  and acknowledge by .

⇒ Press  to enter the next menu item for readability/verification value for second weighing range.

⇒ Press , and current setting will be displayed.

⇒ Select desired setting with  and acknowledge by .

⇒ Press , the unit will return to the menu

⇒ Press  to select the next menu item.

div

div 1 kg

2

div 1 kg











div 2 kg

5

div 2 kg

div

4. Capacity

- ⇒ Press  and the display for entering the capacity for the first weighing range will appear.
- ⇒ Press  and current setting will be displayed.
- ⇒ Select desired setting with  and acknowledge by .
- ⇒ Press  to select the next menu item used to enter the capacity for the second weighing range.
- ⇒ Press  and current setting will be displayed.
- ⇒ Select desired setting with  and acknowledge by .
- ⇒ Press , the unit will return to the menu
- ⇒ Use  to select next menu item.

CAP

CAP 1

1006.00 kg

CAP 1

CAP 2



1015.00 kg

CAP 2

CAP

5. Adjustment / linearization

Adjustment or linearization is required after entering configuration data.
For carrying out adjustment see chap. 6.9.1/step 6 or chap. 6.10.1 for linearisation

- ⇒ Acknowledge using , the current setting is displayed.
- ⇒ Acknowledge by , select desired setting with 
noLin = Adjustment
LinER = Linearisation















CAL

















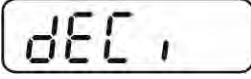

noLin

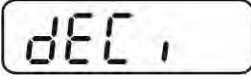





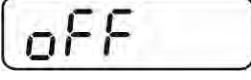









↑
LinER















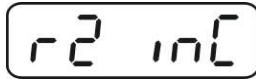

12.4.2 Non verifiable weighing systems (contacts of circuit board [K1] not short-circuited)

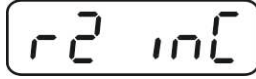
☞ For menu overview see chap. 8.1.

<p>Call up menu</p> <p>⇒ Switch-on balance and during the selftest press  .</p> <p>⇒ Press , ,  subsequently , the first menu block „PO CHK“ will be displayed.</p> <p>⇒ Press  repeatedly until „CAL“ will be displayed.</p> <p>⇒ Press , the first menu item „COUNT“ will be displayed.</p>	   
<p>Navigation in the menu</p> <p>⇒ With help of , the individual menu items can be selected one after the other.</p> <p>⇒ Confirm selected menu item by pressing . The current setting will be displayed.</p> <p>⇒ To change to the available settings, press the navigations keys as described in chap. 2.1.1.</p> <p>⇒ Either save by pressing  or cancel by pressing .</p> <p>⇒ Press  repeatedly to exit menu.</p>	

Parameter selection	
<p>1. Display internal resolution</p> <p>⇒ Press , the internal resolution will be shown.</p> <p>⇒ Return to menu by .</p> <p>⇒ Use  to select another menu item.</p>	  
<p>2. Position decimal point</p> <p>⇒ Press , the currently set position of the decimal dot is displayed.</p> <p>To make changes using the navigation keys (See chap. 2.1.1), select the desired setting. Options 0, 0.0, 0.00, 0.000, 0.0000.</p> <p>Confirm input by .</p> <p>⇒ Use  to select another menu item.</p>	  
<p>3. Weighing scales type, capacity and readability</p> <p>⇒ Press  and current setting will be displayed.</p> <p>⇒ Select desired setting by .</p> <p>„off“ Single-range balance „on“ Dual range balance</p> <p>⇒ Press  to confirm, the display for entering readability (for dual range scales for the first weighing range) appears.</p> <p>⇒ Press , the current setting will be displayed.</p>	   

⇒ Select desired setting with  and acknowledge by  .	
⇒ Press  , the display for entering capacity will appear (at dual range balance for the first range).	
⇒ Press  , the current setting will be shown (such as max. = 2000kg).	
⇒ Using the navigation buttons (see chap. 2.1.1) select the desired setting, the active digit is flashing.	
⇒ Acknowledge with  . In a single-range balance the entry of capacity / readability is finished.	
either in single-range balance	
⇒ Press  , the unit will return to the menu Press  to call up next menu item „CAL“.	
or	
In a dual range balance enter readability/verification value and capacity of the second weighing range.	
⇒ Press  , the display for entering the capacity of the second weighing range will appear.	
⇒ Press  , the current setting will be displayed.	
⇒ Using the navigation buttons (see chap. 2.1.1) select the desired setting, the active digit is flashing.	
⇒ Confirm input by  .	

<p>⇒ Press , the display for entering the readability of the second weighing range will appear.</p> <p>⇒ Press , the current setting will be displayed.</p> <p>⇒ Select desired setting with  and acknowledge by .</p> <p>⇒ Press , the unit will return to the menu</p> <p>⇒ Press  to call next menu item.</p>	   
<p>4. Adjustment or linearisation Adjustment or linearisation is required after entering configuration data. For carrying out adjustment see chap. 6.9.2/step 4 or chap. 6.10.2 for linearisation</p> <p>⇒ Acknowledge using , the current setting is displayed.</p> <p>⇒ Press  to confirm, press  to select the desired setting noLin = Adjustment LineAr = Linearisation</p>	  ↓ 

13 Annex

13.1 Dimensions Support base / wall bracket

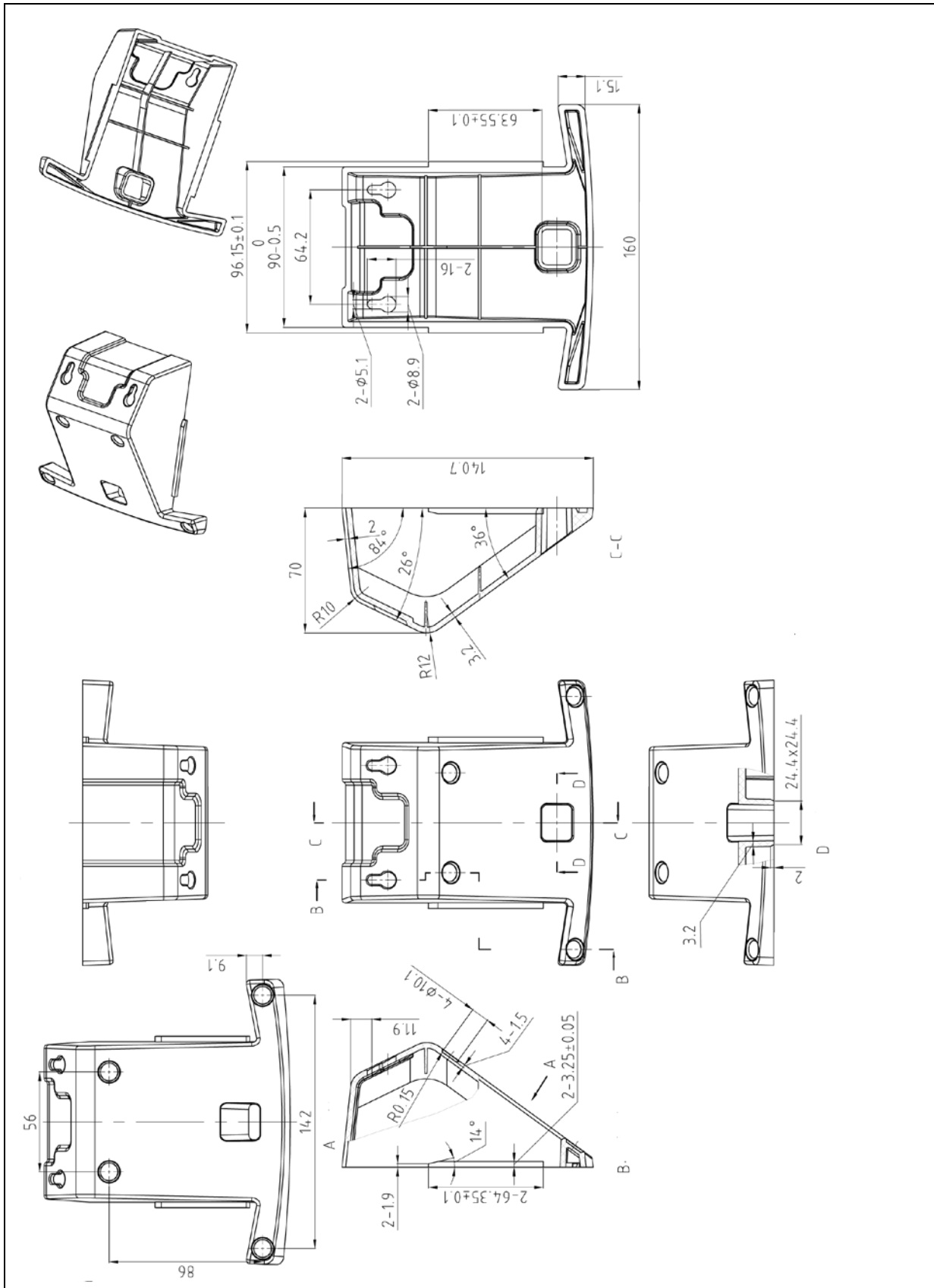

13.2 Declaration of Conformity / Examination Certificate

To view the current EC/EU Declaration of Conformity go to:

www.kern-sohn.com/ce

- i** The scope of delivery for verified weighing balances (= conformity-rated weighing balances) includes a Declaration of Conformity.



We help ideas meet the real world

EU Type Examination Certificate

No. DK0199.626

**KFN-TAM / BFA...AM / BFN...AM / SFB...AM /
NFN...AM / NBB...AM / UFN...AM / UFC...AM /
KFB-TAM / BFB-AM / UFA-AM / UFB-AM / NFB-AM /
IFB-AM**

NON-AUTOMATIC WEIGHING INSTRUMENT

Issued by DELTA Danish Electronics, Light & Acoustics
EU - Notified Body No. 0199

In accordance with the requirements in Directive 2014/31/EU of the European Parliament and Council.

Issued to Kern & Sohn GmbH
Ziegelei 1,
D-72336 Balingen
Germany

In respect of Non-automatic weighing instrument designated KFN-TAM / BFA...AM / BFN...AM / SFB...AM / NFN...AM / NBB...AM / UFN...AM / UFC...AM / KFB-TAM / BFB-AM / UFA-AM / UFB-AM / NFB-AM / IFB-AM with variants of modules of load receptors, load cells and peripheral equipment.
Accuracy class III and IIII
Maximum capacity, Max: From 1 kg up to 199 950 kg
Verification scale interval: $e = \text{Max} / n$
Maximum number of verification scale intervals: $n \leq 6000$ for single-interval and $n \leq 2 \times 3000$ for multi-range and multi-interval (however, dependent on environment and the composition of the modules).
Variants of modules and conditions for the composition of the modules are set out in the annex.

The conformity with the essential requirements in annex 1 of the Directive is met by the application of the European Standard EN 45501:2015 and OIML R76:2006.

The principal characteristics and approval conditions are set out in the descriptive annex to this certificate.

The annex comprises 14 pages.

Issued on 2016-11-16
Valid until 2026-11-16

Signatory: J. Hovgård

DELTA
Venlighedsvej 4
2970 Hørsholm
Denmark

Tel. (+45) 72 19 40 00
Fax (+45) 72 19 40 01
www.delta.dk
VAT No. DK 12275110

Descriptive annex

Contents		Page
1.	Name and type of instrument and modules	2
2.	Description of the construction and function	2
2.1	Construction	2
2.2	Functions	3
3.	Technical data	5
3.1	Indicator	5
3.2	Load receptors, load cells and load receptor supports	6
3.3	Composition of modules	6
3.4	Documents	6
4.	Interfaces and peripheral equipment	7
4.1	Interfaces	7
4.2	Peripheral equipment	7
5.	Approval conditions	7
5.1	Measurement functions other than non-automatic functions	7
5.2	Counting operation is not approved for NAWI	7
5.3	Totalised weight is not a legal value.	7
5.4	Compatibility of modules	7
6.	Special conditions for verification	8
6.1	Composition of modules	8
7.	Securing and location of seals and verification marks	8
7.1	Securing and sealing	8
8.	Location of CE mark of conformity and inscriptions	9
8.1	Indicator	9
9.	Pictures	10
10.	Composition of modules – an example	14

1. Name and type of instrument and modules

The weighing instrument is designated KFN-TAM / BFA...AM / BFN...AM / SFB...AM / NFN...AM / NBB...AM / UFN...AM / UFC...AM / KFB-TAM / BFB-AM / UFA-AM / UFB-AM / NFB-AM / IFB-AM. It is a system of modules consisting of an electronic indicator connected to a separate load receptor and peripheral equipment, such as printers or other devices, as appropriate. The instrument is a Class III or IIII, self-indicating weighing instrument with single-interval, multi-range or multi-interval, an external AC mains adapter and an internal rechargeable battery (optional).

The indicators consist of analogue to digital conversion circuitry, microprocessor control circuitry, power supply, keyboard, non-volatile memory for storage of calibration and setup data, and a weight display contained within a single enclosure.

The modules appear from Sections 3.1, 3.2.1, and 3.2.2; the principle of the composition of the modules is set out in Sections 6.1 and 10.

2. Description of the construction and function

2.1 Construction

2.1.1 Indicator

The indicator is specified in Section 3.1.

Enclosures and keyboard

The indicators are housed in an enclosure made of either ABS plastic (model KFB-TAM / BFB-AM / UFA-AM / UFB-AM / NFB-AM / IFB-AM) or stainless steel (model KFN-TAM / BFA...AM / BFN...AM / SFB...AM / NFN...AM / NBB...AM / UFN...AM / UFC...AM).

The front panels of the indicator comprise:

- a LCD display with appropriate state indicators and 5½ digits.
- A keyboard containing or 6 keys used to enter commands or data into the weight indicator, plus a key for turning the indicator on/off. Each key is identified with a name and/or pictograph.

Electronics

The instruments use a single printed circuit board, which contains all of the instrument circuitry. The metrological circuitry for the models of weight indicator is identical.

All instrument calibration and metrological setup data are contained in non-volatile memory. The power supply accepts an input voltage of 9 – 12 VDC from the external power adapter with input from 230 VAC 50 Hz. The indicator produces a load cell excitation voltage of 5 VDC.

2.1.2 Load receptors, load cells, and load receptor supports

Set out in Section 3.2.

2.1.3 Interfaces and peripheral equipment

Set out in Section 4.

2.2 Functions

The weight indicating instruments are microcontroller based electronic weight indicators that require the external connection of strain gauge load cell(s). The weight information appears in the digital display located on the front panel and may be transmitted to peripheral equipment for recording, processing or display.

The primary functions provided are detailed below.

2.2.1 Display range

The weight indicators will display weight from –Max (net weight) to Max (gross weight) within the limits of the display capacity.

2.2.2 Zero-setting

Pressing the “ZERO” key causes a new zero reference to be established and ZERO annunciator to turn on indicating the display is at the centre of zero.

Semi-automatic zero-setting range: $\pm 2\%$ of Max.

Automatic zero-tracking range: $\pm 2\%$ of Max.

Initial zero-setting range: $\pm 10\%$ of Max.

Zero-setting is only possible when the load receptor is not in motion.

2.2.3 Zero-tracking

The indicators are equipped with a zero-tracking feature, which operates over a range of 4 % of Max and only when the indicator is at gross zero and there is no motion in the weight display.

2.2.4 Tare

The instrument models are provided with a semi-automatic subtractive tare feature activated using the “TARE” key.

When the tare function is active the “G/N” key will toggle the display between showing Net and Gross value.

2.2.5 Printing

A printer may be connected to the optional serial data port. The weight indicator will transmit the current to the printer when the “PRINT” key is pressed.

The printing will not take place if the load receptor is not stable, if the gross weight is less than zero, or if the weight exceeds Max.

2.2.6 Weighing unstable samples

The indicator has a function for weighing unstable samples. It is turned on/off by pressing the “ZERO” and “TARE” keys simultaneously.

2.2.7 Extended resolution ($\times 10$)

The indicators have an extended resolution function. A long press on the TARE key will show the weight flashing with $d = 0.1e$ for 5 seconds.

NB. If the weight includes 5 digits the most significant digit will not be shown.

2.2.8 Display test

A self-test routine is initiated by pressing the on/off key to turn the instrument off, then pressing it again to turn the instrument on. The test routine turns on and off all of the display segments and light indicators to verify that the display is fully functional.

2.2.9 Real time clock

If it is available in the instrument, the real time clock can be activated to get printout with day and time information.

2.2.10 Operator information messages

The weight indicator has a number of general and diagnostic messages, which are described in detail in the user's guide.

2.2.11 Software version

The scales have now software separation. The legally relevant software version is 1.10 and the application software has version 1.xx, where xx can be 00 to 99

The application software version is displayed during the power-up sequence of the instrument.

The legal relevant software version can be displayed by pressing the M+ key during the power-up sequence of the instrument.

The scales that were produced earlier did not have software separation and had the following approved software versions: 1.08

2.2.12 Totalisation

The indicator can be configured with a totalisation function, adding actual weight display values to the memory when pressing "M+" key if the equilibrium is stable.

Pressing "MR" key displays the total accumulated weight.

Pressing "M+" and "MR" key will clear the totalised value.

2.2.13 Battery operation

The indicator can be operated from an internal rechargeable battery, if this option is installed.

2.2.14 Gravity compensation

The gravity adjustment parameter can be used to compensate the weight difference between the place in which the instrument is calibrated and the place of usage. The parameter is before the verification set to the gravity for the place of verification, and after the verification it is set to the gravity for the place of usage. After entering the new value, the calibration is automatically adjusted for the place of usage. This adjustment is sealed.

3. Technical data

The weighing instruments are composed of separate modules, which are set out as follows:

3.1 Indicator

The indicators have the following characteristics:

Type:	KFN-TAM / BFA...AM / BFN...AM / SFB...AM / NFN...AM / NBB...AM / UFN...AM / UFC...AM / KFB-TAM / BFB-AM / UFA-AM / UFB-AM / NFB-AM / IFB-AM
Accuracy class:	III and IIII
Weighing range:	Single-interval, multi-range (2 ranges) or multi-interval (2 partial intervals)
Maximum number of Verification Scale Intervals:	≤ 6000 (class III), ≤ 1000 (class IIII) for single-interval ≤ 3000 (class III), ≤ 1000 (class IIII) for multi-range and multi-interval
Maximum tare effect:	-Max within display limits
Fractional factor:	$p'i = 0.5$
Minimum input voltage per VSI:	1 μ V
Excitation voltage:	5 VDC
Circuit for remote sense:	present on the model with 7-terminal connector
Minimum input impedance:	87 ohm
Maximum input impedance:	1600 ohm
Mains power supply:	9 – 12 VDC / 230 VAC, 50 Hz using external adapter
Operational temperature:	-10 °C to +40 °C
Peripheral interface:	Set out in Section 4

3.1.1 Connecting cable between the indicator and load cell / junction box for load cell(s)

3.1.1.1 4-wire system

Cable between indicator and load cell(s):	4 wires (no sense), shielded
Maximum length:	the certified length of the load cell cable, which shall be connected directly to the indicator,

3.1.1.2 6-wire system

Only to be used for indicator model with a 7-terminal connector for load cell.

Cable between indicator and junction box:	6 wires, shielded
Maximum length:	572 m / mm ²

3.2 Load receptors, load cells and load receptor supports

Removable platforms shall be equipped with level indicators.

3.2.1 General acceptance of modules

Any load cell(s) may be used for instruments under this certificate of type approval provided the following conditions are met:

- 1) A part or test certificate (EN 45501) or OIML Certificate of Conformity (R60) respectively issued for the load cell by a Notified Body responsible for type examination under the Directive 2014/31/EU.
- 2) The certificate contains the load cell types and the necessary load cell data required for the manufacturer's declaration of compatibility of modules (WELMEC 2:2015), and any particular installation requirements). A load cell marked NH is allowed only if humidity testing to EN 45501 has been conducted on this load cell.
- 3) The compatibility of load cells and indicator is established by the manufacturer by means of the compatibility of modules form, contained in the above WELMEC 2 document, or the like, at the time of EC verification or declaration of EC conformity of type.
- 4) The load transmission must conform to one of the examples shown in the WELMEC 2.4 Guide for load cells.

3.2.2 Platforms, weigh bridge platforms

Construction in brief	All-steel or steel-reinforced concrete construction, surface or pit mounted
Reduction ratio	1
Junction box	Mounted in or on the platform
Load cells	Load cell according to Section 3.2.1
Drawings	Various

3.2.3 Bin, tank, hopper and non-standard systems

Construction in brief	Load cell assemblies each consisting of a load cell stand assembly to support one of the mounting feet bin, tank or hopper
Reduction ratio	1
Junction box	Mounted on dead structure
Load cell	Load cell according to Section 3.2.1
Drawings	Various

3.3 Composition of modules

In case of composition of modules, EN 45501 paragraph 3.5 and 4.12 shall be satisfied.

3.4 Documents

The documents filed at DELTA (reference No. T204257) are valid for the weighing instruments described here.

4. Interfaces and peripheral equipment

4.1 Interfaces

The interfaces are characterised “Protective interfaces” according to paragraph 8.4 in the Directive.

4.1.1 Load cell input

A 5-terminal connector or 7-terminal connector for the load cell is positioned on the back of the enclosure.

4.1.2 Other interfaces

The indicator may be equipped with one or more of the following protective interfaces located on the main board or on separate interface boards.

- RS-232C
- Analogue output (0 - 10V / 4 - 20 mA)
- Blue tooth (Transmitted data cannot be regarded as legal values.)

The interfaces do not have to be secured.

4.2 Peripheral equipment

Connection between the indicator and peripheral equipment is allowed by screened cable.

The instrument may be connected to any simple peripheral device with a CE mark of conformity.

5. Approval conditions

5.1 Measurement functions other than non-automatic functions

Measurement functions that will enable the use of the instrument as an automatic weighing instrument are not covered by this type approval.

5.2 Counting operation is not approved for NAWI

The count shown as result of the counting function is not covered by this NAWI approval.

5.3 Totalised weight is not a legal value.

When using the totalization function creating a sum of several weighing results, this sum is only informative, as it is not a legal value.

5.4 Compatibility of modules

In case of composition of modules, EN 45501:2015 annex F shall be satisfied.

6. Special conditions for verification

6.1 Composition of modules

The environmental conditions should be taken into consideration by the composition of modules for a complete weighing instrument, for example instruments with load receptors placed outdoors and having no special protection against the weather.

The composition of modules shall agree with Section 5.4.

An example of a composition of modules for the declaration of conformity document is shown in Section 10.

7. Securing and location of seals and verification marks

7.1 Securing and sealing

Seals shall bear the verification mark of a notified body or alternative mark of the manufacturer according to ANNEX II, module F or D of Directive 2014/31/EU.

7.1.1 Indicator

Access to the configuration and calibration facility requires that a calibration jumper is installed on the main board.

Sealing of the cover of the enclosure - to prevent access to the calibration jumper/switch and to secure the electronics against dismantling/adjustment - is accomplished with wire and seal for the stainless steel enclosures (see fig. 7) and for the ABS enclosure with a brittle plastic stickers. One sticker is placed, so it covers the hole in the enclosure above the calibration switch, and another sticker is placed so access to one of the screws of the enclosure is prohibited (see fig. 8).

7.1.2 Indicator - load cell connector - load receptor

Securing of the indicator, load receptor, and load cell combined is done in one of the following ways:

- Sealing of the load cell connector with the indicator by a lead wire seal

In special cases where the place of installation makes it impossible to use the above sealing:

- Inserting the serial number of the load receptor as part of the principal inscriptions contained on the indicator identification label.
- The load receptor bears the serial number of the indicator on its data plate.

7.1.3 Peripheral interfaces

All peripheral interfaces are “protective”; they neither allow manipulation with weighing data or legal setup, nor change of the performance of the weighing instrument in any way that would alter the legality of the weighing.

8. Location of CE mark of conformity and inscriptions

8.1 Indicator

8.1.1 CE mark

CE mark and supplementary metrological marking shall be applied to the scale according to article 16 of Directive 2014/31/EU.

8.1.2 Inscriptions

Indelibly printed on the front panel overlay or on a brittle plastic sticker located on the front panel overlay:

- Max, Min, e =

On the inscription plate:

- Manufacturer's name and/or trademark, postal address of manufacturer, type name, serial number, type examination certificate no., accuracy class, temperature range, electrical data and other inscriptions.

8.1.2.1 Load receptors

On a data plate:

- Manufacturer's name, type, serial number, capacity

Left to the manufacturer choice as provided in Section 7.1.2;

- Serial no. of the indicator

9. Pictures



Figure 1 KFN-TAM / BFA...AM / BFN...AM / SFB...AM / NFN...AM / NBB...AM / UFN...AM / UFC...AM indicator without front layout.



Figure 2 Indicator front layout for KFN-TAM / BFA...AM / BFN...AM / SFB...AM / NFN...AM / NBB...AM / UFN...AM / UFC...AM



Figure 3 Alternative indicator front layout for KFN-TAM / BFA...AM / BFN...AM / SFB...AM / NFN...AM / NBB...AM / UFN...AM / UFC...AM

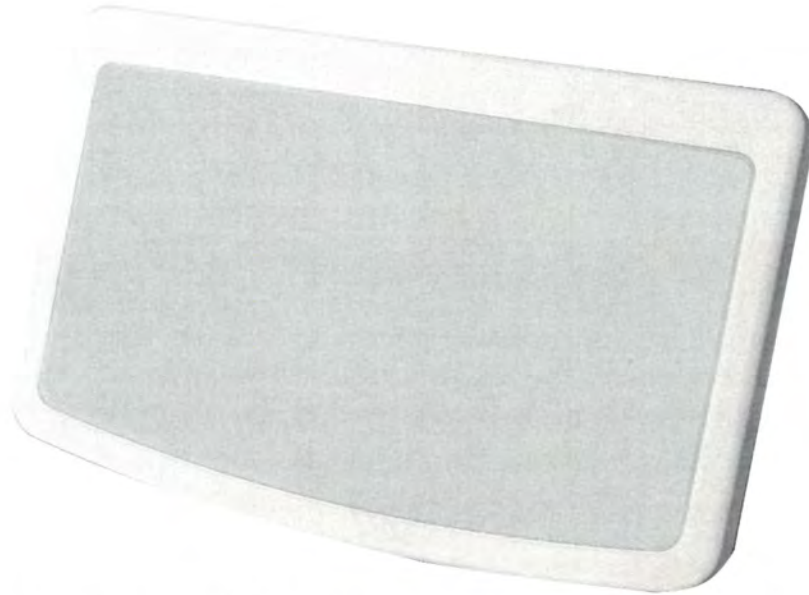

Figure 4 KFB-TAM / BFB-AM / UFA-AM / UFB-AM / NFB-AM / IFB-AM indicator without front layout.

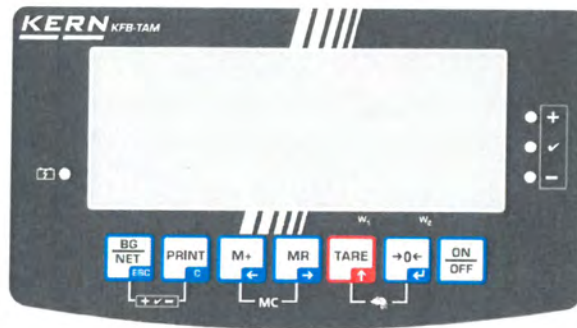

Figure 5 Indicator front layout for KFB-TAM / BFB-AM / UFA-AM / UFB-AM / NFB-AM / IFB-AM



Figure 6 Alternative indicator front layout for KFB-TAM / BFB-AM / UFA-AM / UFB-AM / NFB-AM / IFB-AM

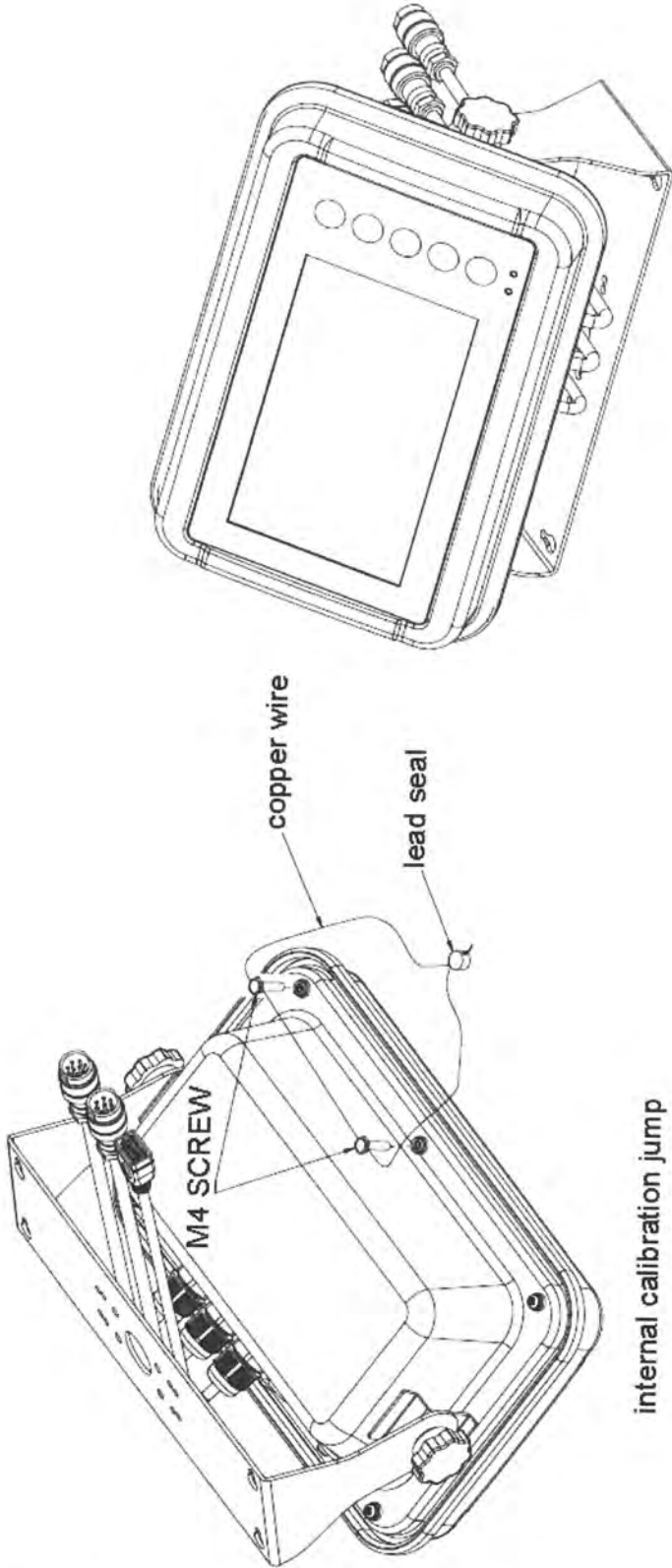
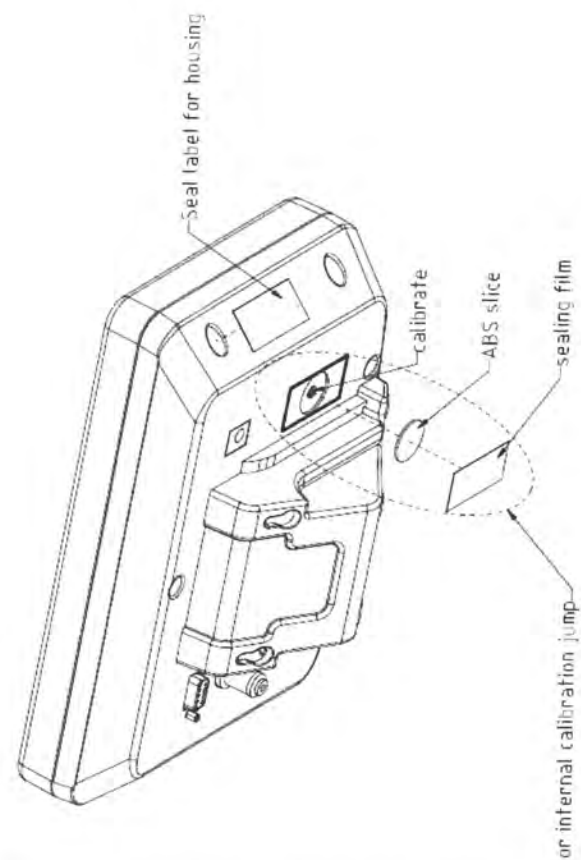

Figure 7 Sealing of KFN-TAM / BFA...AM / BFN...AM / SFB...AM / NFN...AM / NBB...AM / UFN...AM / UFC...AM.





After calibration, assemble the seal cover (ABS) on the hole, then fix the seal film (self-destroyed type), if you want to enter the calibration mode, the calibration switch must be pressed, so the sealing must be destroyed.

Figure 8 Sealing of KFB-TAM / BFB-AM / UFA-AM / UFB-AM / NFB-AM / IFB-AM.

10. Composition of modules – an example

COMPATIBILITY OF MODULES

Ref.: WELMEC 2

Non-Automatic Weighing Instrument, single-interval.

Certificate of EU Type-Approval N°:

		TAC:	DK0199.626	
INDICATOR A/D (Module 1)		Type:	KFB-TAM	
Accuracy class according to EN 45501 and OIML R76:	Class _{ind} (I, II, III or IIII)		III	
Maximum number of verification scale intervals (n _{max}):	n _{ind}		6000	
Fraction of maximum permissible error (mpe):	p ₁		0,5	
Load cell excitation voltage:	U _{exc} [Vdc]		5	
Minimum input-voltage per verification scale interval:	ΔU _{min} [μV]		1	
Minimum load cell impedance:	R _{Lmin} [Ω]		100	
Coefficient of temperature of the span error:	Es [% / 25°C]			
Coefficient of resistance for the wires in the J-box cable:	Sx [% / Ω]			
Specific J-box cable-Length to the junction box for load cells:	(L/A) _{max} [m / mm ²]		572	
Load cell interface:	6-wire (remote sense)			
Additive tare, if available:	T ⁺ [% of Max]		0	
Initial zero setting range:	IZSR [% of Max]		-10 / 10	
Temperature range:	T _{min} / T _{max} [°C]		-10 / 40	
Test report (TR), Test Certificate (TC) or OIML Certificate of Conformity:				
LOAD RECEPTOR (Module 2)		Type:	Platform	
Construction:				
Fraction of mpe:	p ₂		0,5	
Number of load cells:	N		4	
Reduction ratio of the load transmitting device:	R = F _M / F _L		1	
Dead load of load receptor:	DL [% of Max]		10	
Non uniform distribution of the load:	NUD [% of Max]		20	
Correction factor:	Q = 1 + (DL + T ⁺ + IZSR + NUD) / 100		1,4	
LOAD CELL ANALOG (Module 3)		Type:	L6E	
Accuracy class according to OIML R60:	Class _{LC} (A, B, C or D)		C	
Maximum number of load cell intervals:	n _{LC}		3000	
Fraction of mpe:	p ₃		0,7	
Rated output (sensitivity):	C [mV / V]		2	
Input resistance of single load cell:	R _{LC} [Ω]		406	
Minimum load cell verification interval: (v _{min} % = 100 / Y)	v _{min} % [% of E _{max}]		0,02	
Rated capacity:	E _{max} [kg]		150	
Minimum dead load, relative:	(E _{min} / E _{max}) * 100 [%]		0	
Temperature range:	T _{min} / T _{max} [°C]		-10 / 40	
Test report (TR) or Test Certificate (TC/OIML) as appropriate:				
COMPLETE WEIGHING INSTRUMENT		Type:	Single-interval	
Manufacturer: Kern & Sohn GmbH		Type:	KFB-TAM platform scale	
Accuracy class according to EN 45501 and OIML R76:	Class _{WI} (I, II, III or IIII)		III	
Fractions: p _i = p ₁ ² + p ₂ ² + p ₃ ² :	p _i		1,0	
Maximum capacity:	Max [kg]		300	
Number of verification scale intervals:	n		3000	
Verification scale interval:	e [kg]		0,1	
Utilisation ratio of the load cell:	α = (Max / E _{max}) * (R / N)		0,50	
Input voltage (from the load cells):	Δ _U = C * U _{exc} * α * 1000 / n [μV/e]		1,67	
Cross-section of each wire in the J-box cable:	A [mm ²]		0,22	
J-box cable-Length:	L [m]		10	
Temperature range to be marked on the instrument:	Not required	T _{min} / T _{max} [°C]		
Peripheral Equipment subject to legal control:				

Acceptance criteria for compatibility			Passed, provided no result below is < 0		
Class _{WI}	<= Class _{ind} & Class _{LC}	(WELMEC 2: 1)	Class _{WI}	PASSED	
p _i	<= 1	(R76: 3.5.4.1)	1 - p _i	0,0	
n	<= n _{max} for the class	(R76: 3.2)	n _{max} for the class - n	7000	
n	<= n _{ind}	(WELMEC 2: 4)	n _{ind} - n	3000	
n	<= n _{LC}	(R76: 4.12.2)	n _{LC} - n	0	
E _{min}	<= DL * R / N	(WELMEC 2: 6d)	(DL * R / N) - E _{min}	7,5	
v _{min} * √N / R	<= e	(R76: 4.12.3)	e - (v _{min} * √N / R)	0,040	
or (if v _{min} is not given)			Alternative solutions: ↑ ↓		
(E _{max} / n _{LC}) * (√N / R)	<= e	(WELMEC 2: 7)	e - ((E _{max} / n _{LC}) * (√N / R))	0,67	
ΔU _{min}	<= Δu	(WELMEC 2: 8)	Δu - ΔU _{min}	2	
R _{Lmin}	<= R _{LC} / N	(WELMEC 2: 9)	(R _{LC} / N) - R _{Lmin}	527	
L / A	<= (L / A) _{max} ^{WI}	(WELMEC 2: 10)	(L / A) _{max} ^{WI} - (L / A)	20	
T _{range}	<= T _{max} - T _{min}	(R76: 3.9.2.2)	(T _{max} - T _{min}) - T _{range}	45,0	
Q * Max * R / N	<= E _{max}	(R76: 4.12.1)	E _{max} - (Q * Max * R / N)		

Signature and date:

Conclusion PASSED

This is an authentic document made from the program:
"Compatibility of NAWI-modules version 3.2".

