



**KERN & Sohn GmbH**

Ziegelei 1  
D-72336 Balingen  
E-Mail: [info@kern-sohn.com](mailto:info@kern-sohn.com)

Tel: +49-[0]7433- 9933-0  
Fax: +49-[0]7433-9933-149  
Internet: [www.kern-sohn.com](http://www.kern-sohn.com)

## Operating Instructions

Personal weighing scale, Handrail scale, Wheelchair scale, Transportation stretcher balance, Bariatric scale

### **KERN MPS / MTS / MWS / MXS**

MPS 200K100NM  
MPS 200K100PNM  
MTS 300K100NM  
MXS 300K100NM  
MWS 300K100NM  
MWS 400K100DNM  
MWS 300K1LNM

Version 3.3  
2019-05  
GB



**MPS / MTS / MWS / MXS-NM-BA-e-1933**

- D** Weitere Sprachversionen finden Sie online unter [www.kern-sohn.com/manuals](http://www.kern-sohn.com/manuals)
- BG** Други езикови версии ще намерите в сайта [www.kern-sohn.com/manuals](http://www.kern-sohn.com/manuals)
- DK** Flere sprogudgaver findes på websiden [www.kern-sohn.com/manuals](http://www.kern-sohn.com/manuals)
- EST** Muud keeleversioonid leiate Te leheküljel [www.kern-sohn.com/manuals](http://www.kern-sohn.com/manuals)
- E** Más versiones de idiomas se encuentran online bajo [www.kern-sohn.com/manuals](http://www.kern-sohn.com/manuals)
- GR** Άλλες γλωσσικές αποδόσεις θα βρείτε στην ιστοσελίδα [www.kern-sohn.com/manuals](http://www.kern-sohn.com/manuals)
- F** Vous trouverez d'autres versions de langue online sous [www.kern-sohn.com/manuals](http://www.kern-sohn.com/manuals)
- LV** Citas valodu versijas atradīsiet vietnē [www.kern-sohn.com/manuals](http://www.kern-sohn.com/manuals)
- FIN** Muut kieliversiot löytyvät osoitteesta [www.kern-sohn.com/manuals](http://www.kern-sohn.com/manuals)
- LT** Kitas kalbines versijas rasite svetainėje [www.kern-sohn.com/manuals](http://www.kern-sohn.com/manuals)
- GB** Further language versions you will find online under [www.kern-sohn.com/manuals](http://www.kern-sohn.com/manuals)
- RO** Alte versiuni lingvistice veți găsi pe site-ul [www.kern-sohn.com/manuals](http://www.kern-sohn.com/manuals)
- I** Trovate altre versioni di lingue online in [www.kern-sohn.com/manuals](http://www.kern-sohn.com/manuals)
- SK** Iné jazykové verzie nájdete na stránke [www.kern-sohn.com/manuals](http://www.kern-sohn.com/manuals)
- NL** Bijkomende taalversies vindt u online op [www.kern-sohn.com/manuals](http://www.kern-sohn.com/manuals)
- SLO** Druge jezikovne različice na voljo na spletni strani [www.kern-sohn.com/manuals](http://www.kern-sohn.com/manuals)
- P** Encontram-se online mais versões de línguas em [www.kern-sohn.com/manuals](http://www.kern-sohn.com/manuals)
- CZ** Jiné jazykové verze najdete na stránkách [www.kern-sohn.com/manuals](http://www.kern-sohn.com/manuals)
- PL** Inne wersje językowe znajdą Państwo na stronie [www.kern-sohn.com/manuals](http://www.kern-sohn.com/manuals)
- SE** Övriga språkversioner finns här: [www.kern-sohn.com/manuals](http://www.kern-sohn.com/manuals)
- H** A további nyelvi változatok a következő oldalon találhatóak: [www.kern-sohn.com/manuals](http://www.kern-sohn.com/manuals)
- HR** Druge jezične verzije su dostupne na stranici: [www.kern-sohn.com/manuals](http://www.kern-sohn.com/manuals)
- NO** Andre språkversjoner finnes det på [www.kern-sohn.com/manuals](http://www.kern-sohn.com/manuals)



# KERN MPS / MTS / MWS / MXS

Version 3.3 2019-05

## Operating Instructions

**Personal weighing scale without column / with column, Handrail scale, Wheelchair scale/  
Transportation stretcher balance, Bariatric scale**

### Contents

<b>1</b>	<b>Technical data .....</b>	<b>5</b>
1.1	Tolerances altimeter .....	7
<b>2</b>	<b>Declaration of conformity .....</b>	<b>8</b>
2.1	Explanation of graphical symbols for medical devices.....	8
<b>3</b>	<b>Basic directions (general information).....</b>	<b>11</b>
3.1	Use .....	11
3.1.1	Indication .....	11
3.1.2	Contraindication .....	11
3.2	Intended use .....	12
3.3	Inappropriate use .....	13
3.4	Guarantee.....	14
3.5	Monitoring the test substances.....	14
<b>4</b>	<b>Basic safety directions .....</b>	<b>15</b>
4.1	Observing the directions included in the Operating Instructions .....	15
4.2	Personnel training .....	15
4.3	Avoidance of contamination .....	15
4.4	Appropriate use.....	15
<b>5</b>	<b>EMC guidance and manufacturer's declaration .....</b>	<b>16</b>
<b>6</b>	<b>Transport and storage .....</b>	<b>20</b>
6.1	Check upon delivery .....	20
6.2	Packaging / return transport.....	20
<b>7</b>	<b>Unpacking, installation and starting.....</b>	<b>21</b>
7.1	Place of installation, place of use .....	21
7.2	Unpacking.....	21
7.3	Installation and setting of scale .....	22
7.3.1	Scope of delivery.....	38
7.3.2	Installation direction for a model with wall bracket.....	38
7.4	Magnets display unit MWS.....	39
7.4.1	Transportation of balance .....	39
7.5	Mains socket.....	40
7.6	Battery operation/ Rechargeable battery operation (optional).....	40
7.6.1	Battery operation.....	41
7.6.2	Rechargeable battery operation (optional).....	43
7.7	Initial start-up .....	45
7.8	Menu overview of verified scales .....	45
<b>8</b>	<b>Operation .....</b>	<b>46</b>
8.1	Display .....	46
8.2	Display view .....	47
8.3	Overview of keyboard .....	47

<b>9</b>	<b>Using scale .....</b>	<b>48</b>
9.1	Weighing.....	48
9.1.1	Weighing with MWS.....	48
9.2	Taring .....	49
9.3	HOLD function .....	49
9.4	Mother/Child Function.....	50
9.5	Determination of Body Mass Index.....	50
9.5.1	Classification of BMI values .....	51
9.6	PRE-TARE function .....	51
9.6.1	PRE-TARE function with 5 memories .....	52
9.7	Printing function.....	53
9.7.1	Parameters of RS232 interface.....	53
<b>10</b>	<b>Error messages .....</b>	<b>54</b>
<b>11</b>	<b>Service, maintenance, disposal .....</b>	<b>54</b>
11.1	Cleaning / disinfecting.....	54
11.2	Sterilisation .....	54
11.3	Service, maintenance .....	54
11.4	Disposal.....	55
<b>12</b>	<b>Troubleshooting.....</b>	<b>55</b>
<b>13</b>	<b>Verification.....</b>	<b>56</b>
13.1	Adjusting.....	57
13.2	Verification validity period (current status in G) .....	59
13.3	Adjustment key and seals .....	59
13.4	Checking the scale settings concerning scale verification .....	62
13.4.1	Menu overview in the service mode (adjustment switch in the adjustment position) .....	62
13.5	Menu overview.....	62
<b>14</b>	<b>Accessories (optional).....</b>	<b>64</b>

## 1 Technical data

<b>KERN (Type)</b>	<b>MPS 200K100NM/PNM</b>	<b>MTS 300K100NM</b>	<b>MXS 300K100NM</b>
Model	MPS 200K100M/PM	MTS 300K100M	MXS 300K100M
Display	6-position one		
Weighing range (max.)	200 kg	300kg	300 kg
Minimal load (min.)	2 kg	2 kg	2 kg
Verification value (e)	100 g	100 g	100 g
Display	LCD with 25 mm high digits		
Recommended calibration weight, (class)	200 kg (M1)	300 kg (M1)	300 kg (M1)
Signal rise time (typical)	2–3 s		
Warm-up time	10 min		
Operating temperature	+5°C ... +35°C		
Storage temperature	-20°C ... +60°C		
Air humidity	max. 80% (non-condensing)		
Power supply	mains adapter 12 V / 500 mA or 15 V / 300 mA		
	operation with 6 x 1.5 V battery supply, AA type batteries operation time 50 h		
Auto-Off function	after 3 min without load change (possibility of setting)		
Terminal (S x G x W) mm	210 x 110 x 50		
Scale ready for operation (W x D x H) mm	275 x 295 x 58 with column: 275 x 460 x 1010	550x550x1060	550x550x61
Scale plate mm	275 x 295 x 60	550x550	550x550x61
Total weight kg (net)	4.1	21.8	15.0
Verification according to 2014/31/EU	class III		
Medical device according to 93/42/EEC	class I with measuring function		
Rechargeable battery operation (optional)	Loading time:14h; operating time: 35 h; 7.2 V / 2000 mA	Loading time:14h; operating time: 45h; 7.2 V / 2000 mA	Loading time:14h; operating time: 50h; 7.2 V / 2000 mA

<b>KERN (Type)</b>	<b>MWS 300K1LNM</b>	<b>MWS 300K100NM</b>	<b>MWS 400K100DNM</b>
Model	MWS 300K1LM	MWS 300K100M	MWS 400K100DM
Display	6-position one		
Weighing range (max.)	300 kg	300 kg	300kg; 400kg
Minimal load (min.)	2 kg	2 kg	2 kg
Verification value (e)	100 g	100 g	100 g; 200g
Display	LCD with 25 mm high digits		
Recommended calibration weight, (class)	300 kg (M1)	300 kg (M1)	400 kg (M1)
Signal rise time (typical)	2 – 3 sec.		
Warm-up time	10 min; 10 min		
Operating temperature	+ 5° C ... + 35° C		
Storage temperature	- 20°C ... + 60°C		
Air humidity	max. 80 % (non-condensing)		
Power supply	mains adapter 12 V / 500 mA or 15 V / 300 mA		
	operation with 6 x 1.5 V battery supply, AA type batteries operation time 50 h		
Auto-Off function	after 3 min without load change (possibility of setting)		
Terminal (B x T x H) mm	210 x 110 x 45		
Scale ready for operation (W x D x H) mm	1500x860x68	1155x830x65	1255x1060x69
Scale plate mm	800x1200	910x740	1000x1000
Total weight kg (net)	42	28,6	42.2
Verification according to 2014/31/EU	class III		
Medical device according to 93/42/EEC	class I with measuring function		
Rechargeable battery operation (optional)	Loading time:14 h; operating time: 45 h; 7.2 V / 2000 mA	Loading time:14 h; operating time: 45h; 7.2 V / 2000 mA	Loading time:14 h; operating time: 45h; 7.2 V / 2000 mA

### 1.1 Tolerances altimeter

Measured value (cm)	Tolerance (cm)
90	$\pm 0.5$
100	$\pm 1.0$
150	$\pm 1.0$
200	$\pm 1.0$

## 2 Declaration of conformity

To view the current EC/EU Declaration of Conformity go to:

[www.kern-sohn.com/ce](http://www.kern-sohn.com/ce)

**i** The scope of delivery for calibrated weighing balances (= conformity-rated weighing balances) includes a Declaration of Conformity. Solely these weighing balances are classified as medical devices.

### 2.1 Explanation of graphical symbols for medical devices

All medical scales marked in this way meet the requirements of the following directives:



1. 2014/31/EU: Directive on non-automatic weighing instruments
2. 93/42/EC: Directive concerning medical devices



Scales marked in this way underwent the conformity assessment procedure according to Directive 2014/31/EU for scales belonging to 3rd accuracy class.

**WF 1734331**

Designation of the serial number of every device, applied at the device and on the packaging

Number here as example



Identification of the manufacturing date of the medical product.

Year and month here as example

**2019-05**





“Please note the accompanying documents“  
or “Please note operating instructions”



“Observe operating instructions”



“Observe operating instructions”



Identification of manufacturer of medical product in-  
cluding address

**Kern & Sohn GmbH**  
**D-72336 Balingen, Germany**  
**[www.kern-sohn.com](http://www.kern-sohn.com)**



“Electro-medical appliance“  
with attachment for type B

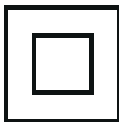

Device protection category II



Dispose of old appliances separately from your  
household waste!

Instead, take them to communal collection points.

  
12 V DC / 500 mA or  
15 V / 300 mA

Display of supply voltage for scales with polarity display



Mains connection



Sealing mark KERN SEAL



Supply voltage direct current



Information

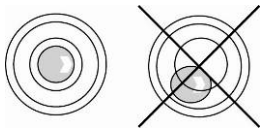

Level balance before use



Electrostatically endangered structural components



When installing or transporting balances with large and heavy platforms (weighing plate folded upwards), ensure that the balance does not fall over or gets damaged.

### 3 Basic directions (general information)



According to the Directive 2014/31/EU scales must be verified to the following application purposes. Article 1, paragraph 4 „Determination of weight in the course of medical practice i.e. weighing of patients for the purpose of health monitoring, diagnosis and medical treatment.”

#### 3.1 Use

##### 3.1.1 Indication

- Determination of body weight in the course of medical practice.
- Used as a „non-automatic scale” i.e. a person
  - is placed carefully on the centre of the weighing plate or on a suspended balance in a suitable holding device.
  - in a baby scales the baby must also be put or set on the weighing pan.
  - For wheel chair scales, a wheel chair together with the person sitting in it is pushed over the ramp into the centre of the weighing plate and/or the electric wheel chair is moved automatically driven onto the weighing plate.
  - When weighing with transportation stretchers, the person is placed with the transportation stretcher centrically on the weighing plate.

After reaching a stable display value, the weight value can be read off.

##### 3.1.2 Contraindication

No contraindications.

### 3.2 Intended use

Depending on the model, the scale is used to determine the weight of standing persons, sitting persons and persons lying on a transportation stretcher and the weight of lying babies in medical treatment rooms, as per model. The balance is suitable for recognising, preventing and controlling illnesses.



The scales equipped with serial interface can only be connected to the equipment compliant with EN60601-1 standard.

- On personal weighing scales, the person should step onto the centre of the weighing platform and remain standing without moving, or on chair scales sit in the centre of the seating surface and remain seated quietly.
- The whole wheel chair is to be pushed onto the weighing plate and/or the electric wheel chair is to be moved automatically onto the weighing plate and the wheels have to be fixed for weighing.
- When persons are weighed on the transportation stretcher, the whole transportation stretcher must be pushed on the centre of the weighing plate and the wheels have to be fixed for weighing.

As soon as a stable weighing value is reached the weighing value can be read. The weighing scale is designed for continuous duty.



The scale platform can only be walked on by people that can stand on it securely with both feet, or sit calmly (in the case of chair scale and wheel chair scale).

Scale platforms or footrests are equipped with anti-slip material which cannot be removed or covered when people are weighed.

When scales equipped with height measure are used, pay attention that the top flap is always folded down after their use to avoid danger of injury.

Before any use, the scale must be checked for correct condition by an authorised person.



When the scale doesn't connect with the transmission cable, please do not touch the transmission port to prevent ESD interference occurs.



### 3.3 Inappropriate use

Do not use the scales for dynamic weighing.

Do not leave a permanent load on the weighing plate. This can damage the measuring equipment.

Be sure to avoid impact shock and overloading the scale in excess of the prescribed maximum load rating (max.), minus any possible tare weight that is already present. This could result in damage of the scale.

Never operate the scale in hazardous locations. The series design is not explosion-proof. Attention should be paid that flammable mixture may also be formed from anaesthesiological means that contain oxygen or laughing gas (nitrous oxide).

Construction alterations may not be made to the scale. This can lead to incorrect weighing results, faults concerning safety regulations as well as to destruction of the scale.

The scale may only be used in compliance with the described guidelines. Other areas of application/planned use must be approved by KERN in writing.

### **3.4 Guarantee**

The guarantee shall become void in the event of the following:

- non-observation of our guidelines in the Operating Instructions,
- use outside the described applications,
- alteration to or opening the device,
- mechanical damage or damage caused by media, liquids,
- usual wear and tear,
- inappropriate erection or electric installation,
- overloading of the measuring equipment,
- scale falling down.



### **3.5 Monitoring the test substances**

The metrology features of the balance and any possible available adjusting weight must be checked at regular intervals within the scope of quality assurance. For this purpose, the responsible user must define a suitable interval as well as the nature and scope of this check. Information is available on KERN's home page ([www.kern-sohn.com](http://www.kern-sohn.com)) with regard to the monitoring of balance test substances and the test weights required for this. Test weights and balances can be adjusted quickly and at a reasonable price at KERN's accredited DKD (Deutscher Kalibrierdienst) calibration laboratory (return to national standard).

In the case of the scales for weighing people provided with the scale to determine a body size, it is recommended to carry out the check of its measuring accuracy because determination of the human body size is always connected with a very large inaccuracy.

## 4 Basic safety directions

### 4.1 Observing the directions included in the Operating Instructions

	⇒ Carefully read this operation manual before setup and commissioning, even if you are already familiar with KERN balances.	
---	---	---

### 4.2 Personnel training

The medical staff must apply and follow the operating instructions for proper use and care of the product.

### 4.3 Avoidance of contamination

To avoid cross contamination (mycosis, ...), the scale plate is to be cleaned regularly. Recommendation: after each weighing which could result in potential contamination (e.g. when there is a direct skin contact during weighing).

### 4.4 Appropriate use

- Always get on and off the medical scales in the presence of a qualified person (see Chapter 4.2).
- Before every use inspect the scales for any signs of damage.
- Maintenance and repeated verification  
Medical scales should be maintained and verified at regular intervals. (see Chapter 11.3)

## 5 EMC guidance and manufacturer's declaration

<b>Guidance and manufacturer's declaration-electromagnetic emissions</b>		
<p>The MPS-NM, MTS-NM, MWS-NM, MXS-NM is intended for use in the electromagnetic environment specified below.</p> <p>The customer or the user of the MPS-NM, MTS-NM, MWS-NM, MXS-NM should assure that it is used in such an environment.</p>		
<b>Emission test</b>	<b>Compliance</b>	<b>Electromagnetic environment-guidance</b>
RF emissions CISPR 11	Group 1	The MPS-NM, MTS-NM, MWS-NM, MXS-NM uses RF energy only for its internal function. Therefore, its RF emissions are very low and are not likely to cause any interference in nearby electronic equipment.
RF emissions CISPR 11	Class B	The MPS-NM, MTS-NM, MWS-NM, MXS-NM is suitable for use in all establishments, including domestic establishments and those directly connected to the public low-voltage power supply network that supplies buildings used for domestic purposes.
Harmonic emissions IEC 61000-3-2	Class A	
Voltage fluctuations /flicker emissions IEC 61000-3-3	Compliance	

<b>Guidance and manufacturer's declaration-electromagnetic immunity</b>			
<p>The MPS-NM, MTS-NM, MWS-NM, MXS-NM is intended for use in the electromagnetic environment specified below.</p> <p>The customer or the user of the MPS-NM, MXS-NM, MWS-NM, MXS-NM should assure that it is used in such an environment.</p>			
<b>Immunity test</b>	<b>IEC 60601 test level</b>	<b>Compliance level</b>	<b>Electromagnetic environment-guidance</b>
Electrostatic discharge(ESD) IEC 61000-4-2	± 6 kV contact ± 8 kV air	± 6 kV contact ± 8 kV air	Floors should be wood, concrete or ceramic tile. If floors are covered with synthetic material, the relative humidity should be at least 30%



Electrical fast transient/burst IEC 61000-4-4	± 2kV for power supply lines + 1kV for input/output lines	± 2kV for power supply lines Not applicable	Mains power quality should be that of a typical commercial or hospital environment.
Surge IEC 61000-4-5	± 1kV line(s) to line(s) ± 2kV line(s) to earth	± 1kV differential mode Not applicable	Mains power quality should be that of a typical commercial or hospital environment.
Voltage Dips, short interruptions and voltage variations on power supply input lines IEC 61000-4-11	<5% UT(>95% dip in UT) for 0,5 cycle 40% UT(60% dip in UT) for 5 cycles 70% UT(30% dip in UT) for 25 cycles <5% UT(>95% dip in UT) for 5 s	<5% UT(>95% dip in UT) for 0,5 cycle 40% UT(60% dip in UT) for 5 cycles 70% UT(30% dip in UT) for 25 cycles <5% UT(>95% dip in UT) for 5 s	Mains power quality should be that of a typical commercial or hospital environment. If the user of the MPS-NM, MTS-NM, MWS-NM, MXS-NM requires continued operation during power mains interruptions, it is recommended that the MPS-NM, MTS-NM, MWS-NM, MXS-NM be powered from an uninterruptible power supply or a battery.
Power frequency(50/60 Hz) magnetic field IEC 61000-4-8	3 A/m	3 A/m	The MPS-NM, MTS-NM, MWS-NM, MXS-NM power frequency magnetic fields should be at levels characteristic of a typical location in a typical commercial or hospital environment.
NOTE UT is the a.c. mains voltage prior to application of the test level.			

**Guidance and manufacturer's declaration-electromagnetic immunity**

The MPS-NM, MTS-NM, MWS-NM, MXS-NM is intended for use in the electromagnetic environment specified below.  
The customer or the user of the MPS-NM, MTS-NM, MWS-NM, MXS-NM should assure that is used in such and environment.

Immunity test	IEC 60601 test level	Compliance level	Electromagnetic environment-guidance
Conducted RF IEC 61000-4-6	3 Vrms 150 KHz to 80 MHz	3 Vrms	<p>Portable and mobile RF communications equipment should be used no closer to any part of the MPS-NM, MTS-NM, MWS-NM, MXS-NM including cables, than the recommended separation distance calculated from the equation applicable to the frequency of the transmitter.</p> <p><b>Recommended separation distance:</b>  <math>d = 1,2 \sqrt{P}</math>  <math>d = 1,2 \sqrt{P}</math> 80MHz to 800 MHz  <math>d = 2,3 \sqrt{P}</math> 800MHz to 2,5 GHz</p> <p>Where <math>P</math> is the maximum output power rating of the transmitter in watts (W) according to the transmitter manufacturer and <math>d</math> is the recommended separation distance in metres (m).</p>
Radiated RF IEC 61000-4-3	3 V/m 80MHz to 2,5 GHz	3 V/m	<p>Field strengths from fixed RF transmitters, as determined by an electromagnetic site survey<sup>a</sup>, should be less than the compliance level in each frequency range<sup>b</sup>.</p> <p>Interference may occur in the vicinity of equipment marked with the following symbol:</p> 

NOTE1 At 80 MHz and 800 MHz, the higher frequency range applies.

NOTE2 These guidelines may not apply in all situations. Electromagnetic propagation is affected by absorption and reflection from structures, objects and people.

a Field strengths from fixed transmitters, such as base stations for radio (cellular/cordless) telephones and land mobile radios, amateur radio, AM and FM radio broadcast and TV broadcast cannot be predicted theoretically with accuracy. To assess the electromagnetic environment due to fixed RF transmitters, an electromagnetic site survey should be considered. If the measured field strength in the location in which the MPS-NM, MTS-NM, MWS-NM, MXS-NM should be observed to verify normal operation. If abnormal performance is observed, additional measures may be necessary, such as re-orienting or relocating the MPS-NM, MTS-NM, MWS-NM, MXS-NM.

b Over the frequency range 150 kHz to 80 MHz, field strengths should be less than 3 V/m.

**Recommended separation distance between portable and mobile RF communications equipment and the MPS-NM, MTS-NM, MWS-NM, MXS-NM**

The MPS-NM, MTS-NM, MWS-NM, MXS-NM is intended for use in an electromagnetic environment in which radiated RF disturbances are controlled. The customer or the user of the MPS-NM, MTS-NM, MWS-NM can help prevent electromagnetic interference by maintaining a minimum distance between portable and mobile RF communications equipment (transmitters) and the MPS-NM, MTS-NM, MWS-NM, MXS-NM as recommended below, according to the maximum output power of the communications equipment.

Rated maximum output power of transmitter  W	Separation distance according to frequency of transmitter m		
	150 kHz to 80 MHz $d = 1,2\sqrt{P}$	80 MHz to 800 MHz $d = 1,2\sqrt{P}$	800 MHz to 2,5 GHz $d = 2,3\sqrt{P}$
0,01	0,12	0,12	0,23
0,1	0,38	0,38	0,73
1	1,2	1,2	2,3
10	3,8	3,8	7,3
100	12	12	23

For transmitters rated at a maximum output power not listed above, the recommended separation distance  $d$  in metres (m) can be estimated using the equation applicable to the frequency of the transmitter, where  $p$  is the maximum output power rating of the transmitter in watts (W) according to the transmitter manufacturer.

NOTE1 At 80 MHz and 800 MHz, the separation distance for the higher frequency range applies.

NOTE2 These guidelines may not apply in all situations. Electromagnetic propagation is affected by absorption and reflection from structures, objects and people.

## 6 Transport and storage

### 6.1 Check upon delivery

Please check the packaging immediately upon delivery and the device during unpacking for any visible signs of external damage.

### 6.2 Packaging / return transport



- ⇒ Keep all parts of the original packaging for a possibly required return.
- ⇒ Only use original packaging for returning.
- ⇒ Prior to dispatch disconnect all cables and remove loose/mobile parts.
- ⇒ Reattach possibly supplied transport securing devices.
- ⇒ Secure all parts such as the weighing platform, power unit etc. against shifting and damage.

## **7 Unpacking, installation and starting**

### **7.1 Place of installation, place of use**

The scale is designed in such a way that reliable weighing results can be achieved under normal application conditions.

By selecting the correct location for your scale, you will be able to work quickly and precisely.

**Therefore, please observe the following when choosing a place of installation:**

- Place the scale on a firm, level surface;
- Avoid extreme heat as well as temperature fluctuation caused by installing the scale next to a radiator or in the direct sunlight;
  
- Protect the scale against direct draughts due to open windows and doors;
- Avoid shaking during weighing;
- Protect the scale against high humidity, vapours and dust;
- Do not expose the device to extreme dampness for longer periods of time. Inadmissible bedewing (condensation of air moisture on the device) can occur if a cold device is taken into a significantly warmer environment. In this case, please keep the device for approx. 2 hours at room temperature after it has been disconnected from mains supply;
- Avoid static charge build-up on the scale and people to be weighed;
- Avoid contact with water.

Major display deviations (incorrect weighing results) are possible if electromagnetic fields occur (e.g. coming from mobile phones or radio equipment) as well as due to static charging and instable power supply. It is necessary then to change the scale location or remove disturbance source.

### **7.2 Unpacking**

Carefully remove individual scale parts or the whole scale from its packaging and position the scale in its intended working location. When the mains adapter is used, be careful not to cause the danger of falling over the power cable.

### 7.3 Installation and setting of scale

Personal weighing scale MPS with wall bracket:



Scope of delivery:



## Personal weighing scale MPS-PM with column:



## Scope of delivery:



- Balance with display unit and tripod
- Mains adapter
- 4 screws

## Assembly:

- ⇒ Remove cap (1)
- ⇒ Unscrew the screw (2)



- ⇒ Pull cable with Plug-in connection (3) through the supporting foot (4) and pull it out at the end (5)

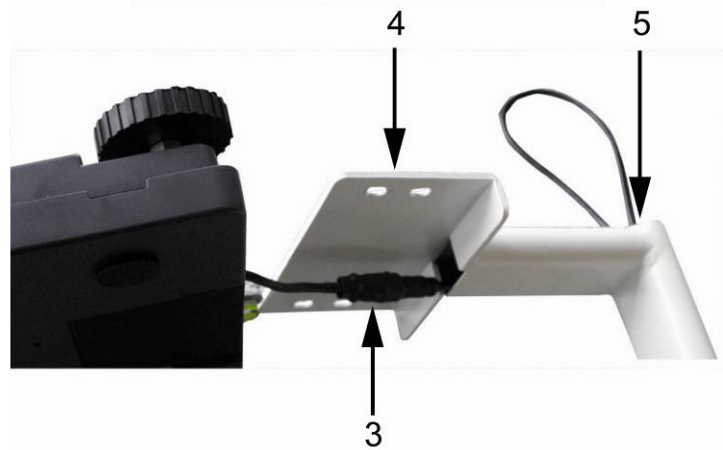

- ⇒ Place supporting foot next to the balance





- ⇒ Introduce cable completely into the tripod tube (6)



- ⇒ Reinsert cap (1)
- ⇒ Screw-in screw (2)

**When screwing the screw ensure that the plug-in connector inside the tripod foot is not squeezed.**

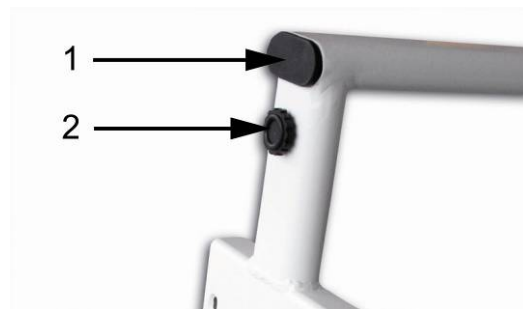

- ⇒ Use the 4 screws to attach the tripod to the bottom of the balance

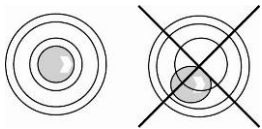
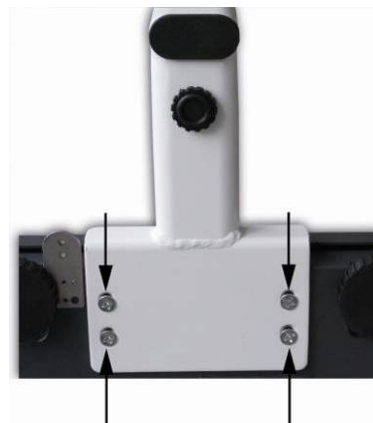

- ⇒ Level balance with foot screws until the air bubble of the water balance is in the prescribed circle.
- ⇒ Check levelling regularly.

⇒ Adjust foot screw of the tripod in a way that the tripod has a safe base and is not loose.

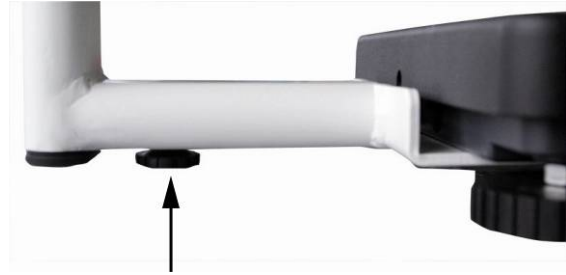

## Mounting height measuring rod MSF 200:

### How to attach to KERN scale

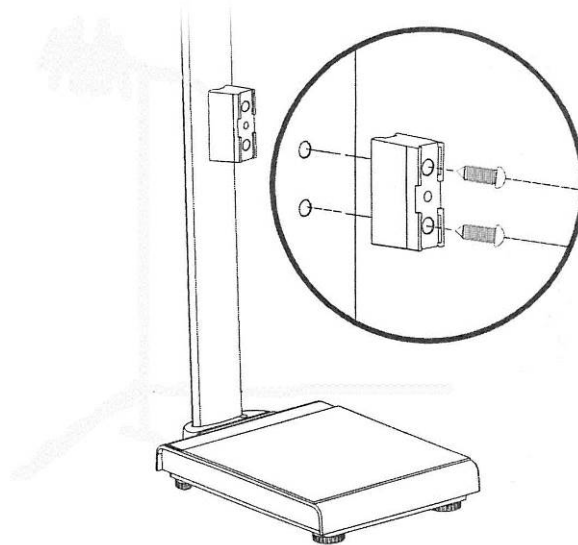

Use the 2 screws for screwing the bracket into the supplied insert nuts on the stand of the scales.

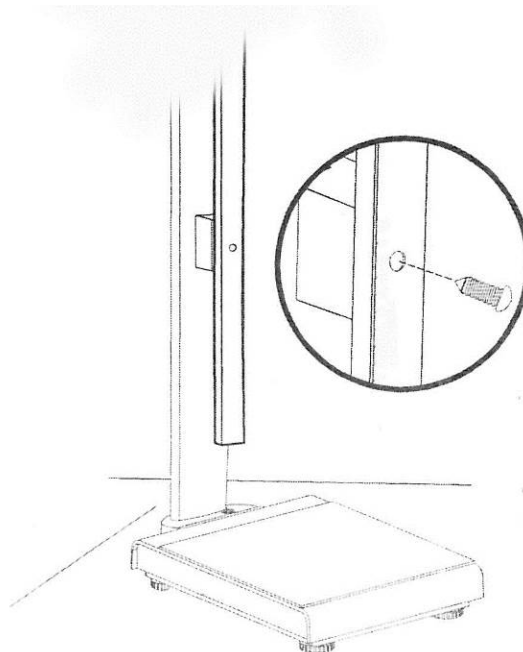

Extend the height measuring rod and tighten it in the lower hole of the bracket with the help of the appertaining screw.



**The height measuring rod can be mounted in the same way at the back of the support stand.**

**Scale MTS with handrail:**



**Scope of delivery:**



Assembly:

Fasten 3 corner elements to the platform, using 4 screws each time.



Place the handrail on 3 corner elements and screw it.



Fasten the terminal holder to the handrail with 3 screws.



Remove the side rubber plugs at both sides of the display.  
Fasten the display to the holder with both handwheels.  
Adjust the display position with handwheels.

**Bariatric scale MXS:**



**Scope of delivery:**



**Wheelchair scale MWS and Transportation stretcher balance MWS-L:**

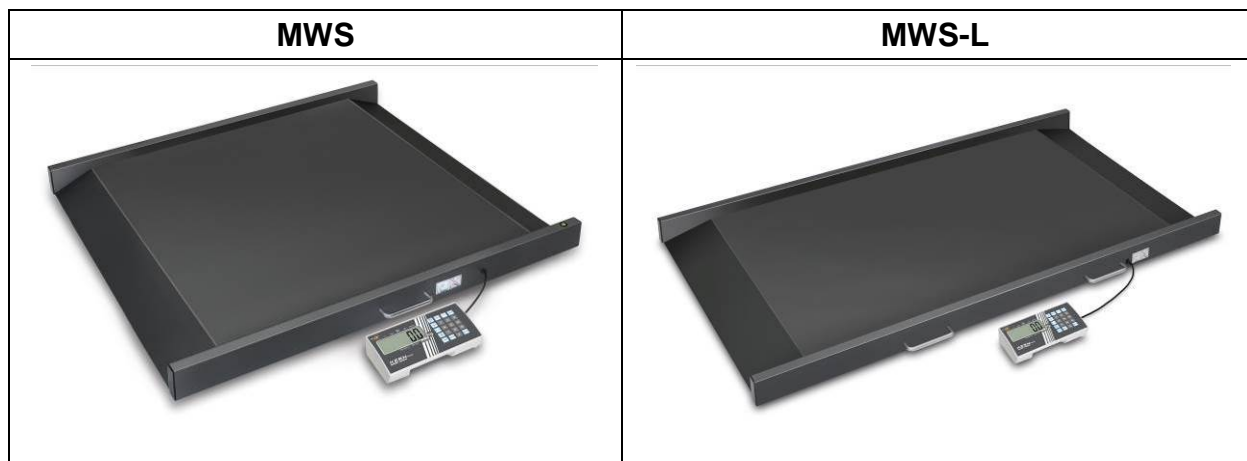

Scope of delivery:



**Direction concerning installation of external column on MPS model without column, MXS and MWS models**

- Fasten the round plate to the aluminium profile with screws.











- Fasten the wall bracket to the top of aluminium profile top with screws.



- Remove the side rubber plugs at both sides of the display.
- Fasten the display to the bracket with both handwheels.
- Adjust the display position with handwheels.
- Fasten the cable with cable clips.



## Assembly of holding bracket set MWS-A02 at the MWS models

	<p><b>1</b> <b>Railing</b></p>		<p><b>6</b> <b>Screw</b></p>
	<p><b>2</b> <b>Handrail butts</b></p>		<p><b>7</b> <b>Hexagonal socket wrench</b></p>
	<p><b>3</b> <b>Cross strut</b></p>		<p><b>8</b> <b>Screw</b> (for installation cross strut)</p>
	<p><b>4</b> <b>Support</b></p>		<p><b>9</b> <b>Screw</b> (for installation display unit)</p>
	<p><b>5</b> <b>Tapped bush</b></p>		

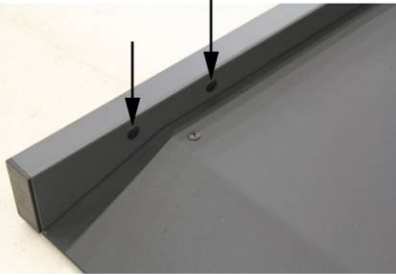
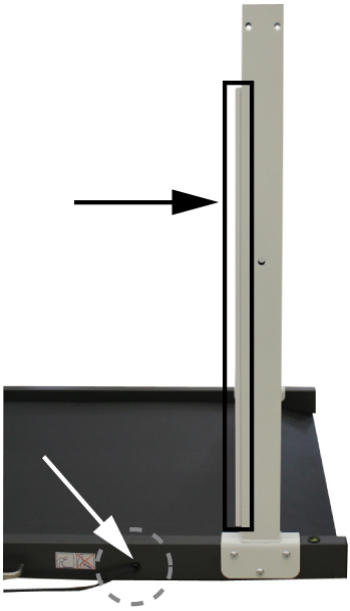
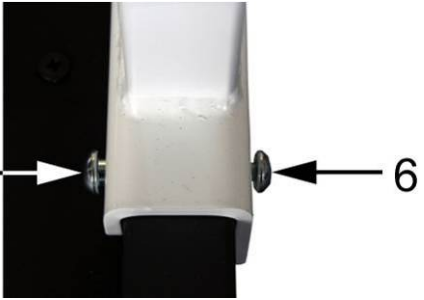

We recommend engaging a second person to assist you during installation.

	<p>Carefully remove the plastic cover from the weighing scale, ensuring that the weighing scale does not get scratched in the process.</p>
	<p>Mount all 4 handrail butts (2) on the weighing scale frame.</p> <p><b>i</b> Ensure that the handrail butt and cable conduit are positioned to the right of the power unit supply point. (s. fig.)</p>
	<p>Take the two hexagonal socket wrenches (7) and fix all handrail butts with the help of the screws 6 (3x) and the tapped bushes 5 (2x) as shown on the illustration.</p> <p><b>i</b> Make sure that all screws are tightened properly.</p>



Ensuring perfect fit, put the handrail containing three holes for the display unit on the handrail butt (1) and cable conduit. (see fig.)



Using the holders 4 (2x) fasten the handrail to the handrail butts. Once again, use screws 6 (3x) and tapped bushes 5 (3x).

Carry out same sequence of operations for second handrail.



Use the two screws (8) to fasten the cross strut (3).



Use the three screws to fasten the mounting plate to the handrail.



Take a screw driver and remove the plastic covers from both sides of the display unit.



Screw the display unit to the handle, using the synthetic screws included in the delivery,

**The reading direction of the display unit is optional and can be adapted during the installation of the application.**

**Display unit facing inward**



**Display unit facing outward**



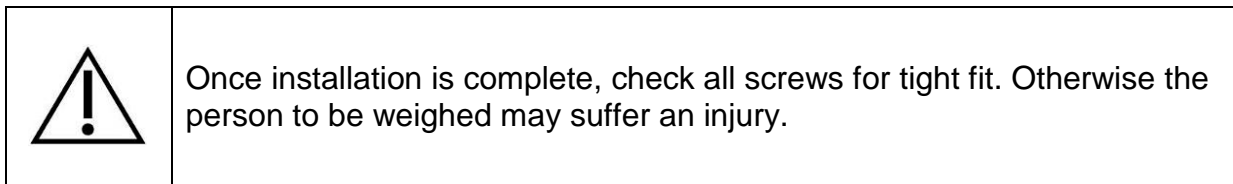
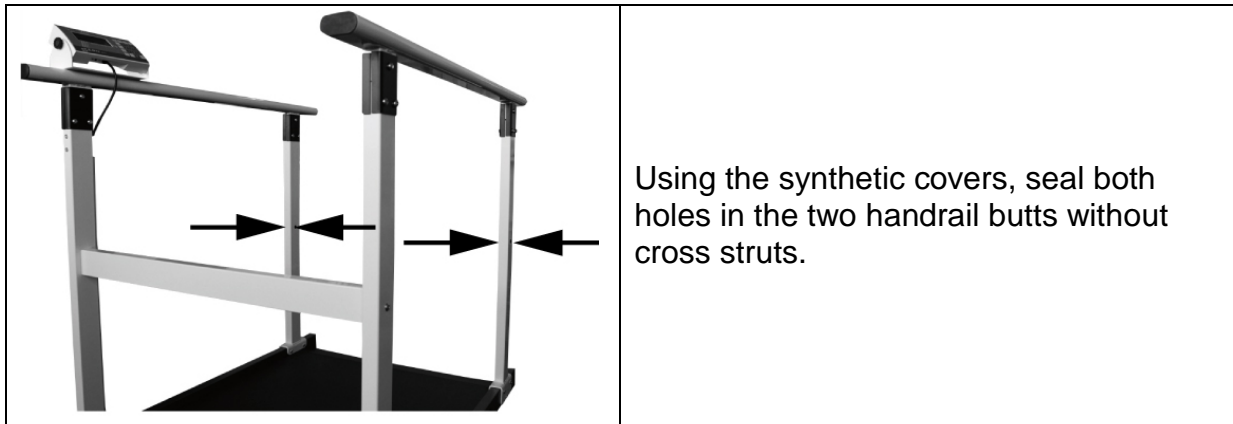

### General direction concerning setting up the previously mentioned scales

Place a personal weighing scale in the intended location and level it with the adjustable rubber feet until the air bubble in the spirit level (located in the centre of the scale plate) is in the centre.

When scales with large and heavy platforms are installed and transported (a scale plate folded upwards), take care not to drop a scale as this could cause its damage.



### 7.3.1 Scope of delivery

#### Standard accessories:

- Mains adapter (complaint with EN 60601-1 standard).
- Operating Instructions

### 7.3.2 Installation direction for a model with wall bracket

(personal weighing scale, bariatric scale, wheelchair scale, transportation stretcher scales)

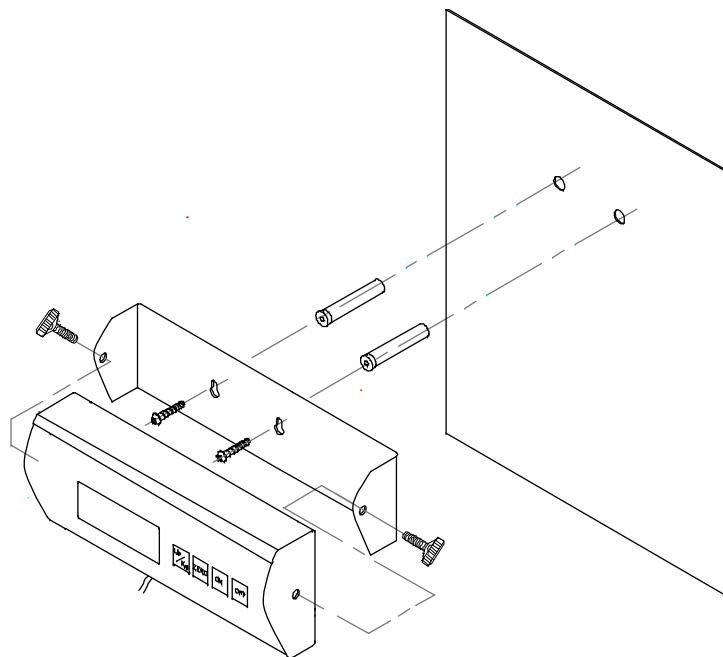

## 7.4 Magnets display unit MWS

The display unit of the MWS has two magnets on the rear side, use these magnets to fix the display unit on metallic surfaces.



### 7.4.1 Transportation of balance

There exists the possibility to fix the display unit at the platform using the two magnets on the rear side, whereby the balance and the display unit can be transported together without problems (see fig. below).



## 7.5 Mains socket

- Power supply is carried out by means of the external mains adapter which also provides separation between mains and a scale. The printed voltage value must be compliant with local voltage.
- Use only admitted and original KERN mains adapters compliant with EN 60601-1 standard.
- The scales can be supplied only by the delivered power supply. It is prohibited to supply it via a PC.

## 7.6 Battery operation/ Rechargeable battery operation (optional) (only models with battery operation and rechargeable battery operation)



Connection **CN 4** for  
batteries (AA x 6)

Connection **CN 3** for  
rechargeable battery



## 7.6.1 Battery operation

On models where the back of the display unit is not directly accessible, remove the two black rotary knobs from both sides of the display unit in order to open the battery compartment and remove the display unit from the holder.

- ⇒ Lift-off the battery cover on the lower side of the balance

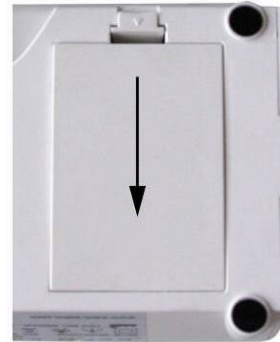

- ⇒ Carefully take out the battery holder (1)



- ⇒ Insert 6 batteries (AA).  
**Ensure that the batteries are inserted in the correct direction**



- ⇒ Insert battery holder with the inserted batteries into the display unit  
**Ensure that the cables are not squeezed**



- ⇒ Close the battery cover

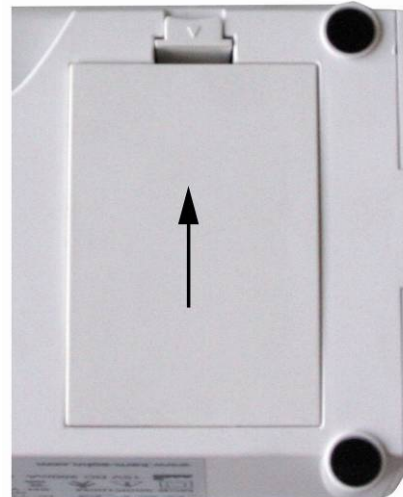

If the batteries are run down, "LO" appears in the display. To turn off, press the  button and immediately change the batteries. If the balance is not used for a longer time, take out the batteries and store them separately. Leaking battery liquid could damage the balance.

## 7.6.2 Rechargeable battery operation (optional)

When an optional rechargeable battery is used, proceed as follows:

On models where the back of the display unit is not directly accessible, remove the two black rotary knobs from both sides of the display unit in order to open the battery compartment and remove the display unit from the holder.

- ⇒ Lift-off the battery cover on the lower side of the balance

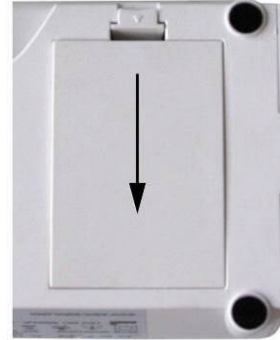

- ⇒ Carefully take out the battery holder (1)

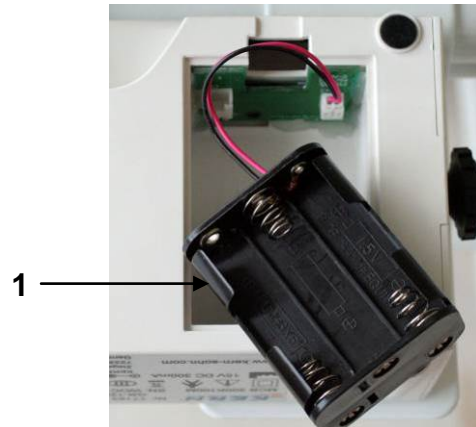

- ⇒ Carefully pull-out plug (2) from the connection **CN 4** (3)

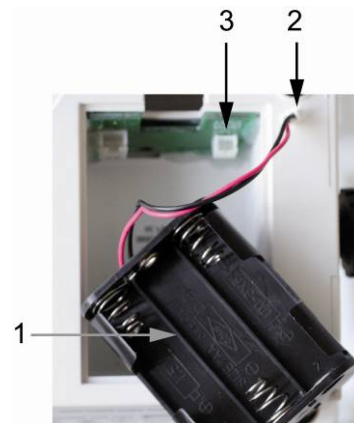

- ⇒ Carefully insert the rechargeable battery block and insert plug into connection **CN 3**  
**Ensure that the cables are not squeezed**



- ⇒ Close the battery cover

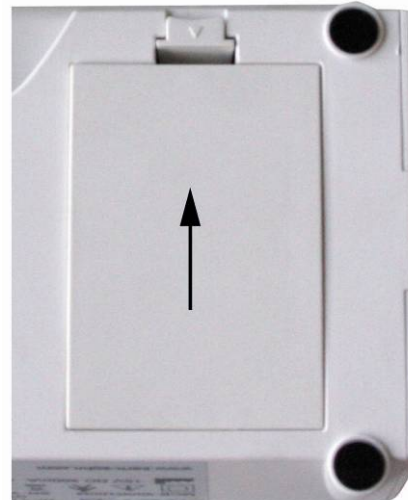

If the rechargeable battery is exhausted, „LO“ is displayed. The rechargeable battery is loaded via the provided plug-in power supply unit (loading time 14 h for a complete loading). If the balance is not used for a longer time, take out the rechargeable battery and store it separately. Leaking liquid could damage the balance.

## 7.7 Initial start-up

To obtain accurate weighing results with electronic scales, the appropriate operating temperature is to be provided for them (refer to „Warm-up time”, section 1). During warm-up the scale must be connected to power supply and switched on (mains socket or batteries).

The accuracy of the scale depends on the local acceleration of gravity. The value of acceleration of gravity is given on the rating plate.

## 7.8 Menu overview of verified scales

When the scale is switched on, hold the [→0←] key pressed for about 3 seconds until the display shows successively the „SETUP” and „A.OFF” symbols. Selection is carried out with the [TARE] → and [HOLD] ↓ keys.

Function	Settings	Description
<b>SEtuP</b>		
<b>A. oFF</b> Automatic cutout Auto Off	180 s	Automatic shutdown after 3 min
	240 s	Automatic shutdown after 4 min
	300 s	Automatic shutdown after 5 min
	oFF	Automatic shutdown off
	120 s	Automatic shutdown after 2 min
<b>burr</b> Audio signal		
	on	Acoustic signal on
	oFF	Acoustic signal off
<b>End</b>	Exit menu by pressing 	

## 8 Operation

### 8.1 Display

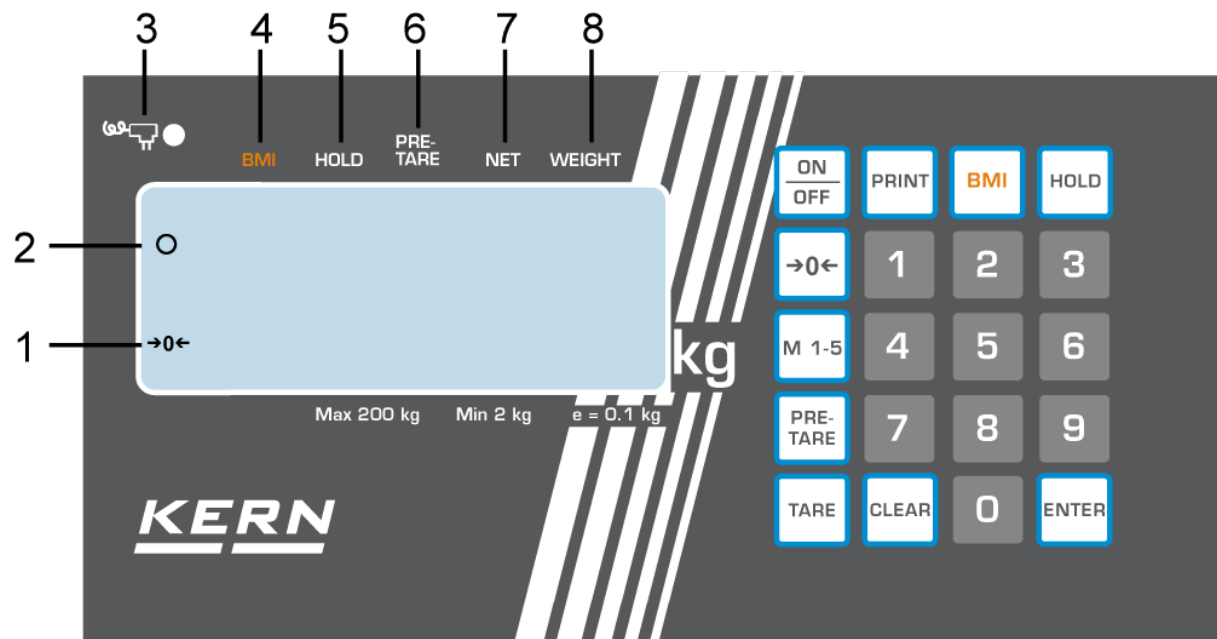

MPS 200K100NM  
MPS 200K100PNM

## 8.2 Display view

No.	Display	Description
1	[→0←]	Scale zero display: If the scale does not show exactly zero value although the scale pan is unloaded, press the [→0←] key. After a short waiting time, the scale will be zeroed again.
2	[o]	Stabilisation display: If the display shows the stabilisation display [o], the scale is in the stable condition. When the scale is in the unstable condition, the stabilisation display [o] disappears.
3		It is illuminated when mains supply is via the mains adaptor.
4	BMI ▲	Calculated value of the body mass index (BMI).
5	HOLD ▲	Hold function / saving function is active.
6	PRE-TARE ▲	Initially set tare value is active.
7	NET ▲	The net weight is displayed.
8	WEIGHT ▲	The present weight value is displayed.

## 8.3 Overview of keyboard

Key	Description
ON/OFF	Switching on/off the scale
PRINT	Data transmission via interface
BMI	Determination of Body Mass Index
HOLD	Hold function / determination of stable weighing value
→0←	The scale is reset to 0,0 kg display. It is possible to set max. up to 2% of maximal load for verified scales, and 2% or 100% of maximal load for common scales (possibility of selection in the menu)
M 1-5	Memories 1–5 were called

PRE-TARE	Calling the tare function with set values
TARE	Taring the scale
CLEAR	Clearing the digits entered manually
0..9	Entering digits
ENTER	Using the entered digits

## 9 Using scale

### 9.1 Weighing

- ⇒ Switch on the scale with the **[ON/OFF]** key. The diagnostic scale self-check is performed and then the software version is displayed. The scale is ready for weighing when the „0,00 kg” weight display is shown.  
Direction: The **[→0←]** key makes it possible to zero the scale if necessary and at any time.
- ⇒ Place a person in the middle of the scale. Wait until the stability display (o) is shown and then read the weighing result.

#### Direction:

If a person is heavier than the weighing range, the display will show the „Err” symbol (= overload).

#### 9.1.1 Weighing with MWS

Due to the great dimensions and the big weighing range especially suitable for weighing of immobile patients on transportation stretchers, wheelchairs or overweight patients in the adiposity range

##### 9.1.1.1 Weighing with transportation stretcher or wheelchair

- ⇒ Place transportation stretcher/wheelchair with patient on the centre of the scales
- ⇒ Arrest the brakes of the transportation stretcher/of the wheelchair



Do not leave the patient unattended

- ⇒ When the patient is lying/sitting quietly, read weighing value 1
- ⇒ Loosen the brakes and carefully pull off the transportation stretcher/wheelchair with patient
- ⇒ After that weigh the transportation stretcher/wheelchair without patient and subtract this weight from weighing value 1, from there results the patient's weight.





## 9.2 Taring

The dead weight of any initial load used for weighing may be tared away by pressing the key, so that the following weighing shows the real weight of a person to be weighed.

- ⇒ E.g. when a rubber mat is put on the scale plate, the scale does not show 0 value.
- ⇒ To start the taring process, press the **[TARE]** key. Now internal weight saving is performed and value of **0.0 kg** is displayed.
- ⇒ Place a person in the middle of the scale plate.
- ⇒ Then read the weight on the display.

### Direction:

The scale can store only one tare value.

When the scale is unloaded, the saved tare value is displayed with „negative” sign. To delete the saved tare value, unload the scale plate and then press the **[TARE]** key.

## 9.3 HOLD function

The scale is provided with the integrated hold function (determination of average value). It enables people to be weighed accurately although they are not still on the scale plate.

Note: Determination of average value is not possible when a person moves too much.

- ⇒ Switch on the scale with the **[ON/OFF]** key. The diagnostic scale self-check is performed. The scale is ready for weighing when the „**0.00 kg**” weight display is shown.
- ⇒ Place a person in the centre of the scale plate.
- ⇒ Press the **[HOLD]** key. When the triangle is flashing on the display, the scale takes some measuring values and then the calculated average value is displayed.
- ⇒ Press the **[HOLD]** key again to return the scale to the normal weighing mode.
- ⇒ Pressing the **[HOLD]** key makes it possible to activate the function at any time.

## 9.4 Mother/Child Function

The “Mother/Child” function makes it possible to determine the body weight of infants and small children held in an adult’s arms.

- ⇒ Turn on the scales using the **[ON/OFF]** switch. The scales enters the self-diagnostic mode. The device is ready for operation as soon as “**0.00 kg**” is shown on the weight display.
- ⇒ Position the adult person in the middle of the scales platform. After showing the stability indicator, the scales displays the person’s weight. A triangle symbol is shown under the “WEIGHT” symbol.
- ⇒ Press the **[TARE]** button and the readout changes to “**0.00 kg**”.
- ⇒ Place the child in the arms of the adult person. After showing the stability indicator, the scales displays the child’s weight. The triangle symbol is now displayed under the “NET” symbol.
- ⇒ Press the **[TARE]** button again and the readout again changes to “**0.00 kg**”.
- ⇒ After stepping off the scales, the total weight of the adult person and the child is displayed as a negative value.
- ⇒ Press the **[TARE]** button again. The saved tare value is cancelled and the scales can be used for weighing again.

## 9.5 Determination of Body Mass Index

When you obtain a stable weight and display shows **0.0 kg**, place a person in the middle of the scale plate. Wait until the weighing value is stable. Then press the **BMI** key. Now enter a body height.

Please take note that reliable determination of BMI index is only possible for body height from 100 cm to 250 cm and weight > 10 kg.

A body height entered as the last one is flashing on the display. Now you can enter a different value with the numerical keypad. Confirm the entered value with the **ENTER** key, and then a person’s BMI index will be displayed.

When the BMI index value is displayed, it is presented with the arrow pointing the **BMI** symbol. To return to the weighing mode, press the **BMI** key once again and the arrow at the **BMI** symbol will disappear.

### 9.5.1 Classification of BMI values

Classification of weight for adults over 18 years on the basis of Body Mass Index according to WHO, 2000 EK IV and WHO 2004 (WHO - World Health Organization).

Category	BMI (kg/m <sup>2</sup> )	Risk of diseases accompanying overweight
Underweight	< 18.5	low
Normal weight	18.5 – 24.9	average
Overweight	≥ 25.0	
Preobesity	25.0 – 29.9	slightly increased
I degree of obesity	30.0 – 34.9	increased
II degree of obesity	35.0 – 39.9	high
III degree of obesity	≥ 40	very high

### 9.6 PRE-TARE function

When a tare weight (rubber mat, clothes, ...) is known, this value can be entered manually.

If the **PRE-TARE** key is pressed shortly, the flashing display will be shown.

The PRE-TARE function is active as long as the small arrow is pointing the "**PRE-TARE**" symbol on the display.

The value used as the last one will be displayed. If a different value is required, a new weight value can be entered with the numerical keypad. By pressing the **ENTER** key, the new value is confirmed and used. Then the entered value with minus sign will be shown on the display.

When a person is placed on the scale plate, the display will show a weight value less the value entered previously.

Pressing the **PRE-TARE** key again will return the scale to the normal weighing mode.

### 9.6.1 PRE-TARE function with 5 memories

Owing to this function it is possible to store 5 Pre-Tare values (e.g. for different wheelchairs), and then call up them if necessary.

#### **Saving PRE-Tare values:**

To enable a later calling up values from the memory, they are to be entered into the memory first. It is carried out in the following way:

The scale plate is unloaded, and the scale display is showing **0,0 kg**.

Put a weight, whose value is to be saved (e.g. an empty wheelchair), on the scale plate and wait until a stable weight display is shown.

Press the **M1-5** key repeatedly until the display will show the „ni” (**M**) symbol.

Press the **key with digit (1..5)** shortly to indicate which number a value is to be saved under. The previously displayed weight value is flashing for 3 seconds.

When the flashing is finished, press again the **key with digit** previously pressed and the weighing value is saved in the memory (short audible signal).

By pressing the **CLEAR** key, the scale will return to the weighing mode without saving the value.

The display will show the real value of the weight placed on the scale plate. When the weight is removed, the display will show **0,0 kg**.

#### **Calling up the PRE-Tare value from memory:**

Press the **PRE-Tare** key repeatedly until the display will show the „ni” (**M**) symbol.

Pressing the **key with digit (1..5)** will display the flashing weight value saved there.

The small arrow, additionally shown on the display, is pointing to the „**PRE-TARE**” symbol. By pressing another **key with digit (1..5)**, the appropriate also flashing weight value will be displayed. Press the **ENTER** key and the value will be accepted and shown on the display as the PRE-Tare value with minus sign.

Now you can place e.g. a person in a wheelchair or on the transportation stretcher on the scale, and only a person’s weight will be displayed.

To return to the normal weighing mode when the scale plate is unloaded, press the PRE-Tare key shortly again. This will also result in disappearing the small arrow pointing the „**PRE-TARE**” symbol.

## Printing Pre-Tare memory (refer also to section 8.6):

To do this, press the **PRE-Tare** key repeatedly until the display will show the „ni” (M) symbol.

Short pressing the **PRINT** key will activate printing of the values saved in 5 memories.

M1	0.0 kg
M2	7.0 kg
M3	10.0 kg
M4	30.0 kg
M5	50.0 kg

## 9.7 Printing function

To use this function, you need the RS232 interface cable (available as accessories) which is connected with the round plug at the terminal back.

**Note:** In medical applications, only the peripheral equipment meeting EN 60601-1 standard can be connected to the interface.

When a scale is in the weighing mode, pressing the **PRINT** key will result in output of the particular data, presented below, via the interface. It is the standard way to output data, which cannot be changed.

G	88.8 kg	Gross weight
T	2.0 kg	Taring weight
N	86.8 kg	Net weight
	180.0 cm	Size of patient
	24.4 BMI	BMI value

### 9.7.1 Parameters of RS232 interface

Set parameters of the scale interface on the connected device. It is not possible to change the scale parameters.

Baud rate: 9600 bps  
Parity check: no  
Data length: 8 bits  
Stop bit: 1 bit  
Handshake: no or Xon/Xoff  
Data code: ASCII

## 10 Error messages

The following messages can be shown on the display during switching on or using the scale.

ERRL: Too small weight on the scale.

ooooo: The scale plate was loaded during switching on the scale. Unload the scale plate.

ERR: Overload, too large weight on the scale plate.

## 11 Service, maintenance, disposal

### 11.1 Cleaning / disinfecting

Clean weighing platform (such as seat) as well as casing with household detergents or commercially available disinfectants, e.g. 70% isopropanol. We recommend a disinfectant suitable for wiping disinfection. Please follow manufacturer's instructions.

Do not use abrasive or aggressive cleaners such as spirits or alcohol or similar as they might damage the high-quality surface.

To prevent cross-contamination (fungal skin infection) please observe the following time intervals for disinfection:

- Weighing plate before and after any measurement with direct skin contact
- When required:
  - Display
  - Touch-sensitive keyboard



Do not spray disinfectants onto appliance.

Make sure that disinfectant does not penetrate the interior of the balance.

Remove dirt immediately.

### 11.2 Sterilisation

Sterilisation of the appliance not allowed.

### 11.3 Service, maintenance

The device may only be operated and maintained by trained service technicians who are authorised by KERN.

We recommend regular verification of conformity with technical safety requirements (STK).

Disconnect the scale from mains supply before its opening.

## 11.4 Disposal

Disposal of packaging and device must be carried out by an operator according to valid national or regional law of the location where the device is used.

## 12 Troubleshooting

The scale should be switched off for a short time following an interruption in the program sequence and disconnected from mains supply. It is then necessary to repeat the weighing process from the beginning.

### Interruption

### Possible cause

Weight display is not illuminated.

- The scale is not switched on.
- The mains supply connection has been interrupted (mains cable not plugged in/faulty).
- Check the fuse of the mains adapter / green LED is illuminated next to the fuse.
- Mains failure.
- Batteries are incorrectly inserted or discharged.
- No batteries.

Weight display changes continuously

- Draught/air movement
- Table/floor vibrations
- The weighing plate is in contact with foreign matters or is installed incorrectly.
- Electromagnetic fields/static charging (choose a different location for the scale, switch off an interfering device if possible).

The weighing result is obviously incorrect

- The scale display is not set to zero
- Incorrect adjustment.
- Great fluctuations in temperature.
- Warm-up time was ignored.
- Electromagnetic fields/static charging (choose a different location for the scale, switch off an interfering device if possible).

Should other error messages occur, switch the scale off and then on again. If the error message remains, inform the manufacturer.

## 13 Verification

### General introduction:

According to EU directive 2014/31/EU balances must be officially verified if they are used as follows (legally controlled area):

- a) For commercial transactions if the price of goods is determined by weighing.
- b) For the production of medicines in pharmacies as well as for analyses in the medical and pharmaceutical laboratory.
- c) For official purposes
- d) For manufacturing final packages
- e) Determination of mass in the practice of medicine that is, weighing patients for reasons of medical supervision during medical surveillance, examination and treatment.

In cases of doubt, please contact your local trade in standard.

### Verification notes:

An EU type approval exists for balances described in their technical data as verifiable. If a balance is used where obligation to verify exists as described above, it must be verified and re-verified at regular intervals.

Re-verification of a balance is carried out according to the respective national regulations. For verification validity period, s. chap. 13.1.

The legal regulation of the country where the balance is used must be observed!



### **Verification of the balance is invalid without the seal.**

The seal marks attached on balances with type approval point out that the balance may only be opened and serviced by trained and authorised specialist staff. If the seal mark is destroyed, verification loses its validity. Please observe all national laws and legal regulations. In Germany a re-verification will be necessary.



**Balances with obligation to verify must be taken out of operation if:**







- **The weighing result of the balance is outside the error limit.** Therefore, in regular intervals load balance with known test weight (ca. 1/3 of the max. load) and compare with displayed value.
- **The reverification deadline has been exceeded.**



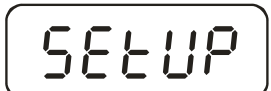

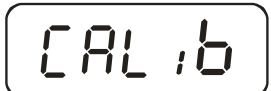

**13.1 Adjusting**

Observe stable environmental conditions. The warm-up time (refer to chapter 1) is required to ensure the scale stabilisation.

**Note:**

In the case of verified scales, adjusting is locked with the jumper. To carry out adjusting, the jumper is to be set in the adjusting position (central position). (refer to 12.2).

Operation	Display
Turn the scale on using the [ON/OFF] key.	
Press and keep the [→0←] key pressed for about 3 seconds until the display shows successively the „SETUP” and „UNIT” symbol.	 ↓ 
Press the [TARE] key until the „CAL ib” symbol is displayed.	
Press the [HOLD] key.	
Press the [TARE] key. The triangle ◀ must be displayed at the top left side of the display. If not, press the [TARE] key.	
Press the [HOLD] key repeatedly until the „CAL 0” symbol is displayed.	 ↓ 

<p>Press the <b>[TARE]</b> key, the display will show the present numerical value.</p> <p>Then press the <b>[ENTER]</b> key.</p>	 ↓ 
<p>Press the <b>[HOLD]</b> key.</p>	
<p>Press the <b>[TARE]</b> key.</p> <p>Enter the required calibration weight value (refer to chapter 1, „Technical data“): Select the item to be changed with the <b>HOLD</b> key and set its numerical value with the <b>[TARE]</b> key.</p>	
<p>Confirm by pressing the <b>[ENTER]</b> key.</p>	
<p>Place the calibration weight carefully in the centre of the scale plate, and the display will show a numerical value. Press the <b>[ENTER]</b> key. The adjustment process is started.</p>	
<p>When the adjustment is finished successfully, the scale is automatically switched over to the weighing mode again and the calibration weight value will be displayed.</p> <p>Remove the calibration weight.</p>	
<p><b>Note:</b> In the case of verified scales, switch off a scale and set the adjustment switch in verification position.</p>	

### 13.2 Verification validity period (current status in G)

Personal scales (including chair and wheelchair scales) in hospitals	4 year
Personal scales, when not located in hospitals (for example, doctor's offices and nursing homes)	unlimited
Baby weighing scales and mechanical birth weight scales	4 year
Bed scales	2 year
Scales in dialysis stations	unlimited

Rehab clinics and health authorities are treated as hospitals.  
(4 years of verification validity)

Not treated as hospitals (verification validity not limited) are dialysis stations, nursing homes and doctor's surgeries.

(Details derived from: „Information by the verification authority, weighing scales applied in medical use“)

### 13.3 Adjustment key and seals

When verification of a scale is finished, the positions indicated on the scale are sealed.

**Verification of a scale without a seal is invalid.**

**Position of seals:**

1. Backside



2. Battery compartment



3. MPS

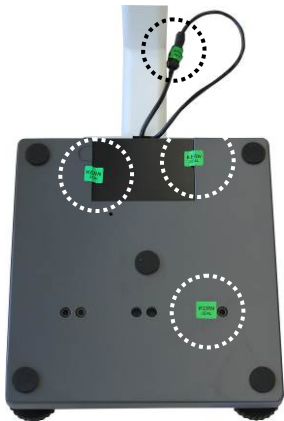

#### 4. MXS, MTS

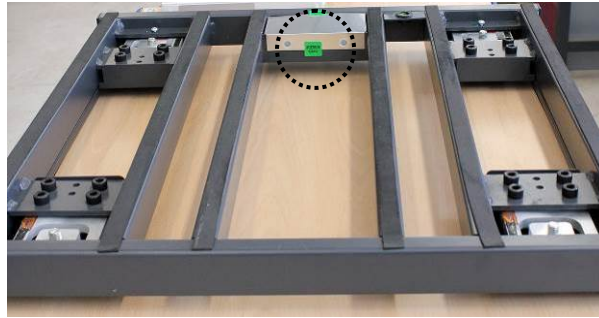

#### 5. MWS



#### Position of adjustment switch:

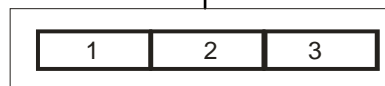
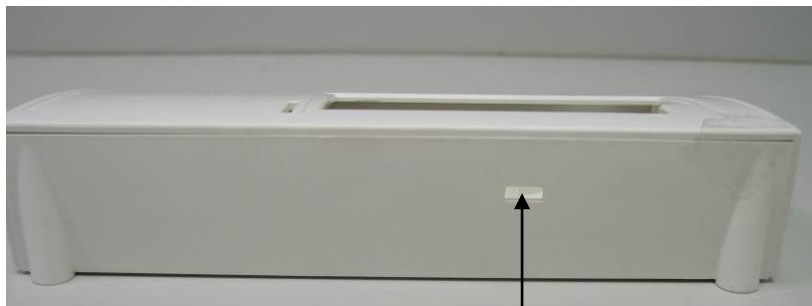

Position of adjustment switch	Status
1. left side	not documented
2. centre	adjustment position - adjustment is possible
3. right side	verification position – adjustment locking

### 13.4 Checking the scale settings concerning scale verification

To start the adjustment function, a scale is to be switched over into the service mode. To do this, set the adjustment switch in the adjustment position (refer to chapter 12.2).

The service mode makes it possible to change all parameters of a scale. Service parameters cannot be changed because it may have an influence on the scale settings.

#### 13.4.1 Menu overview in the service mode (adjustment switch in the adjustment position)

Overview is only used to check the set parameters by authorised verification offices. Changes may only be introduced in parameters of the automatic switching off function „*R.OFF*” and audible signal „*bUrr*”.

##### Navigation in menu:

- When the scale is switched on, press and hold the [→0←] key pressed for about 3 seconds until the display shows successively the „SETUP” and „UNIT” symbol.
- Press the [TARE] key repeatedly until the required function is displayed.
- Confirm the selected function with the [HOLD] key. The first parameter will be displayed. Select the required parameter with the [HOLD] key and confirm the selection with the [TARE] key.

To exit the menu and save the settings, press the [TARE] key until the „End” symbol is displayed and then confirm with the [HOLD] key. The scale is automatically returned to the weighing mode.

Selection is carried out with the [HOLD] → and [TARE] ↓ key.

### 13.5 Menu overview

Function	Settings	Description
<b>SEtuP</b>		
<b>Unit</b>	on-off	Weighing unit kg
<b>Grad</b>	3000 d – 6000 d – 10000 d – 500 d – 1000 d – 1500 d - 2500 d - 2000 d	Partition steps, weighing range (max.) and readout (d)

<b>Ut.-d</b>	Full – S-Ut	Selection Single-range (Full)- / Multiple-range balance (S-Ut)
<b>FIIE</b>	Fast – Nor. - SLo	Filter: fast - normal - slow
<b>Auto 0</b>	0.25 d – 0.5 d – 1 d – 3 d - OFF	Auto-Zero Tracking
<b>Stab</b>	0.25 d – 0.5 d – 1 d – 3 d - off	Stabilisation range
<b>Orang</b>	2 Pct – 100 Pct.	Zero range: 2 % / 100 %
<b>Ould</b>	9 d – 2 Pct.	Overload range: 9 d / 2 %
<b>CALib</b>	CAL-U – CAL-0 CAL-5	Adjustment
<b>A.Off</b>	120s/180s/240s/ 300s/off	Automatic shutdown function

<b>burr</b>	on/off	Audio signal
<b>default</b>		Reset to default setting
<b>End</b>	Exit menu by pressing 	

**Description:**

<b>Unit</b>	Weight unit: kg
<b>GrAd.</b>	Scale divisions, weighing range (max.) and read-out (d)
<b>Ut.-d.</b>	Selection of multi-range / single-range scale
<b>FULL</b>	Single-range scale

S-8t	Multi-range scale
FiltE	Filter: fast / normal / slow
Auto0	Automatic zero tracking: 0,25 d/ 0,5 d/ 1 d/ 3 d/ OFF
StAb.	Stabilisation range: 0,25 d/ 0,5 d/ 1 d/ 3 d/ OFF
OrAng	Zero range: 2% / 100%
Overd	Overload range: 9 d / 2%
Calib	Adjusting
ROFF	Auto off function: 120 s / 180 s / 240 s / 300 sec/ OFF
bUrr	Audible signal: ON/OFF
dEFLt	Restoring the factory settings (default settings)
End	Exiting the menu

#### 14 Accessories (optional)

Item number	Product
MWS-A01	Tripod
MWS-A02	Hand rail