

KERN[®] **KERN & Sohn GmbH**

Ziegelei 1
72336 Balingen-Frommern
Germany

☎ +0049-[0]7433-9933-0
FAX +0049-[0]7433-9933-149
✉ info@kern-sohn.com

Operating instructions Medical Chair scales

KERN MCN

TMCN 200K-1M-A
Version 1.3
2022-06
GB



TMCN_A-BA-e-2213

- D** Weitere Sprachversionen finden Sie online unter www.kern-sohn.com/manuals
- BG** Други езикови версии ще намерите в сайта www.kern-sohn.com/manuals
- DK** Flere sprogudgaver findes på websiden www.kern-sohn.com/manuals
- EST** Muud keeleversioonid leiate Te leheküljel www.kern-sohn.com/manuals
- E** Más versiones de idiomas se encuentran online bajo www.kern-sohn.com/manuals
- GR** Άλλες γλωσσικές αποδόσεις θα βρείτε στην ιστοσελίδα www.kern-sohn.com/manuals
- F** Vous trouverez d'autres versions de langue online sous www.kern-sohn.com/manuals
- LV** Citas valodu versijas atradīsiet vietnē www.kern-sohn.com/manuals
- FIN** Muut kieliversiot löytyvät osoitteesta www.kern-sohn.com/manuals
- LT** Kitas kalbines versijas rasite svetainėje www.kern-sohn.com/manuals
- GB** Further language versions you will find online under www.kern-sohn.com/manuals
- RO** Alte versiuni lingvistice veți găți pe site-ul www.kern-sohn.com/manuals
- I** Trovate altre versioni di lingue online in www.kern-sohn.com/manuals
- SK** Iné jazykové verzie nájdete na stránke www.kern-sohn.com/manuals
- NL** Bijkomende taalversies vindt u online op www.kern-sohn.com/manuals
- SLO** Druge jezikovne različice na voljo na spletni strani www.kern-sohn.com/manuals
- P** Encontram-se online mais versões de línguas em www.kern-sohn.com/manuals
- CZ** Jiné jazykové verze najdete na stránkách www.kern-sohn.com/manuals
- PL** Inne wersje językowe znajdą Państwo na stronie www.kern-sohn.com/manuals
- SE** Övriga språkversioner finns här: www.kern-sohn.com/manuals
- H** A további nyelvi változatok a következő oldalon található: www.kern-sohn.com/manuals
- HR** Druge jezične verzije su dostupne na stranici: www.kern-sohn.com/manuals
- NO** Andre språkversjoner finnes det på www.kern-sohn.com/manuals



KERN TMCN

Version 1.3 2022-06

Operating manual chair scales

Contents

1	Technical data	5
2	Declaration of conformity	6
2.1	Explanation of the graphic symbols for medical products	6
3	Appliance overview	9
3.1	Overview of displays	11
3.2	Keyboard overview	12
3.3	Dimensions	13
4	Basic Information (General)	14
4.1	Specific function.....	14
4.1.1	Indication	14
4.1.2	Contraindication.....	14
4.2	Proper use	14
4.3	Non-intended product use / contraindications	16
4.4	Warranty	16
4.5	Monitoring of Test Resources	16
4.6	Plausibility check	17
4.7	Reporting serious incidents.....	17
5	Basic Safety Precautions	18
5.1	Pay attention to the instructions in the Operation Manual	18
5.2	Personnel training.....	18
5.3	Preventing contamination	18
5.4	Preparation for use	18
6	Electromagnetic compatibility (EMC)	19
6.1	General hints	19
6.2	Electromagnetic emission of interferences.....	20
6.3	Electromagnetic immunity to interferences.....	21
6.3.1	Crucial features of performance	23
6.4	Minimum distances	23
7	Transport and storage	24
7.1	Testing upon acceptance.....	24
7.2	Packaging / return transport.....	24
8	Unpacking, Installation and Commissioning	25
8.1	Installation Site, Location of Use	25
8.2	Unpacking.....	25
8.3	Scope of delivery	25
8.4	Installing the chair scales	26
8.4.1	Levelling	26
8.5	Battery operation	28
8.6	Rechargeable battery operation using an optional battery power pack	30
8.7	Mains connection.....	30
8.7.1	Safety cable	31
8.8	Initial Commissioning.....	31

9	Operation	32
9.1	Weighing.....	32
9.2	Taring	33
9.2.1	Subsequent tare weight.....	33
9.2.2	Pretare	33
9.3	HOLD function	36
9.4	Calculation of the Body Mass Index.....	37
9.4.1	Classification of BMI values	38
9.5	Automatic switch-off function „AUTO OFF“	38
9.6	Signal tone when pressing button	40
9.7	Setting time and date	41
10	Menu	42
10.1	Navigation in the menu	42
10.2	Menu overview.....	43
11	Communication with peripheral devices via KUP connection	45
11.1	KERN Communications Protocol (KERN Interface Protocol).....	45
11.2	Data output after pressing the PRINT button < manual >	46
11.3	Automatic data output < auto>	47
11.4	Continuous data output < cont >	47
11.5	Data format.....	48
11.6	WLAN	48
11.7	Print function.....	50
12	Bluetooth	51
13	Alibi memory (optional)	51
14	Error messages	52
15	Servicing, maintenance, disposal	53
15.1	Cleaning	53
15.2	Cleaning / disinfecting.....	53
15.3	Sterilisation	53
15.4	Servicing, maintenance.....	53
15.5	Disposal.....	53
16	Instant help for troubleshooting	54
17	Verification	55
17.1	Verification validity period (current status in D)	56
18	Adjustment	57
18.1	Adjustment switch and seal marks	59

1 Technical data

KERN	MCN 200K-1M
Item no./ Type	TMCN 200K-1M-A
Display	6-digit
Readability (d)	0.1 kg
Weighing range (max)	250 kg
Minimum load (min)	2 kg
Verification value (e)	100 g
Accuracy for first verification	$\leq 50 \text{ kg} = 0.5 \text{ e}$ $> 50 \text{ kg} - 200 \text{ kg} = 1 \text{ e}$ $> 200 \text{ kg} - 250 \text{ kg} = 1.5 \text{ e}$
Linearity	$\pm 0.1 \text{ kg}$
Display	LCD with 25mm high digits
Recommended adjustment weight, not added (Category)	200 kg (M1)
Warm-up time	10 min
Operating temperature	10° C + 40° C
Storage and transportation environment	-20 to +60°C, and 30% to 90% relative humidity
Humidity of air	max. 80 % (not condensing)
Atmospheric pressure (kPa)	70kpa-106kpa
Input Voltage	6 V / 1 A
Battery use	6 x 1.5 V AA
	Battery working range: 48 hours background illumination off 24 hours background illumination on Loading time: 8 hours
Auto Off	after 3, 5, 15, 30 min without load change (adjustable)
Dimensions fully mounted (W x D x H) mm	625 x 990 x 985
Dimensions Weighing surface (W x D) mm	390 x 360
Weight kg (net)	23,3
Rechargeable battery operation	optional; 3.8 VDC – 4.2 VDC / 3700 mAh
Medical product in accordance with 93/42/EEC	Category I with measuring function
Verification in accordance with 2014/31/EU	Category III
Data interface	Intern: Wi-Fi Optional / Extern: KUP (RS232, Bluetooth, USB-D, Extension box)

2 Declaration of conformity

The current EC/EU Conformity declaration can be found online in:

www.kern-sohn.com/ce



For verified weighing scales (= weighing scales assessed for conformity) the declaration of conformity is included in the scope of delivery.

Only these balances are medical products.

2.1 Explanation of the graphic symbols for medical products

All medical balances with this mark fulfill the following guidelines:

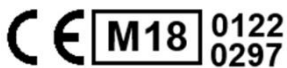

1. 2014/31/EU: Guideline for non-automatic balances
2. 93/42/EEC: Guideline for medical products



Balances which carry this mark, are conformity-evaluated as per accuracy class III of the EC-guideline 2014/31/EU. Accuracy of the balance see chapter 1 Technical data.

WF 1734331

Designation of the serial number of every device, applied at the device and on the packaging

Number here as example



2022-06

Identification of the manufacturing date of the medical product.

Year and month here as example



“Attention, please note the accompanying document“,
or “Please note operating instructions”



“Observe operating instructions”



“Observe operating instructions”



Identification of manufacturer of medical product including address

Kern & Sohn GmbH
D-72336 Balingen, Germany
www.kern-sohn.com



“Electro-medical device“
with attachment for type B

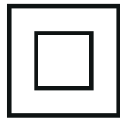

Device protection class II



Dispose of old appliances separately from your household waste!

Instead, take them to communal collection points.



Display of supply voltage for scales with polarity display



The chair scales may not be used for the transport of people and objects!
Do not step onto the foot rests when stepping or leaving the chair scales!

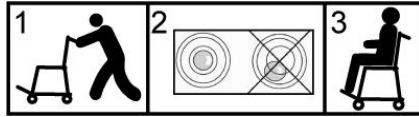

After the balance having been transported to the patient, the balance must be levelled prior to weighing.



Mains connection

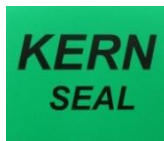

Sealing mark KERN SEAL



Supply voltage direct current



Information

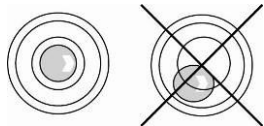

Level balance before use



Electrostatically endangered structural components

3 Appliance overview



- 1. Seat pan
- 2. Bubble level
- 3. Display Unit
- 4. Manipulations

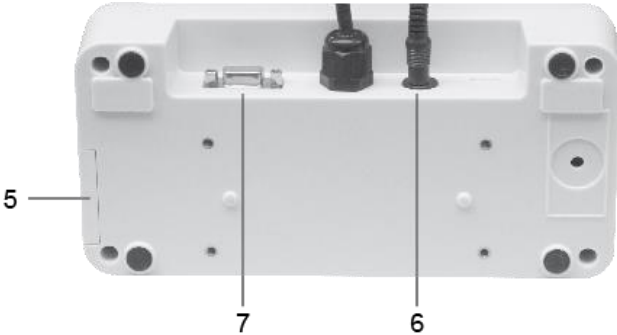

5 Rechargeable battery compartment 6 Mains connection 7 KUP

Parking brake and adjustment foot



Parking brake opened



Parking brake closed







Foot rest and adjustment foot

Folding arm rests









3.1 Overview of displays

	Stability display	Scales are in a steady state
	Zeroing display	Should the balance not display exactly zero despite empty weighing plate, press the  button. Your balance will be set to zero after a short standby time.
NET	Net weight display	Illuminated when net weight is displayed Illuminated after weighing scale was tared
GROSS	Gross weight display	Illuminated when gross weight is displayed
HOLD	HOLD function	HOLD function active
BMI	BMI function	Illuminated while BMI function is enabled
	Battery symbol	Shows the charging capacity of the batteries
kg	Weighing unit	Displays the weighing unit
	WiFi-interface	Shows the connection to the cableless network

3.2 Keyboard overview



Button	Designation	Function
	ON/OFF-button	Turn on/off
	HOLD button	Hold function/Calculation of a stable weight value In menu: <ul style="list-style-type: none"> Select menu items For numeric entry: <ul style="list-style-type: none"> Lowering numeric value
	BMI button	Calculation of the Body Mass Index In menu: <ul style="list-style-type: none"> Return to weighing mode
	Print button	Data transfer via interface In menu: <ul style="list-style-type: none"> Select menu items For numeric entry: <ul style="list-style-type: none"> Increase numerical value
	Function key	Function quick key Quick call-up of a function stored before
	Zeroing key	Weighing scale will be reset to „0.0“ In menu: <ul style="list-style-type: none"> Confirm selection For numeric entry: <ul style="list-style-type: none"> Change decimal digit Confirm entry
	TARE key	Tare balance

3.3 Dimensions

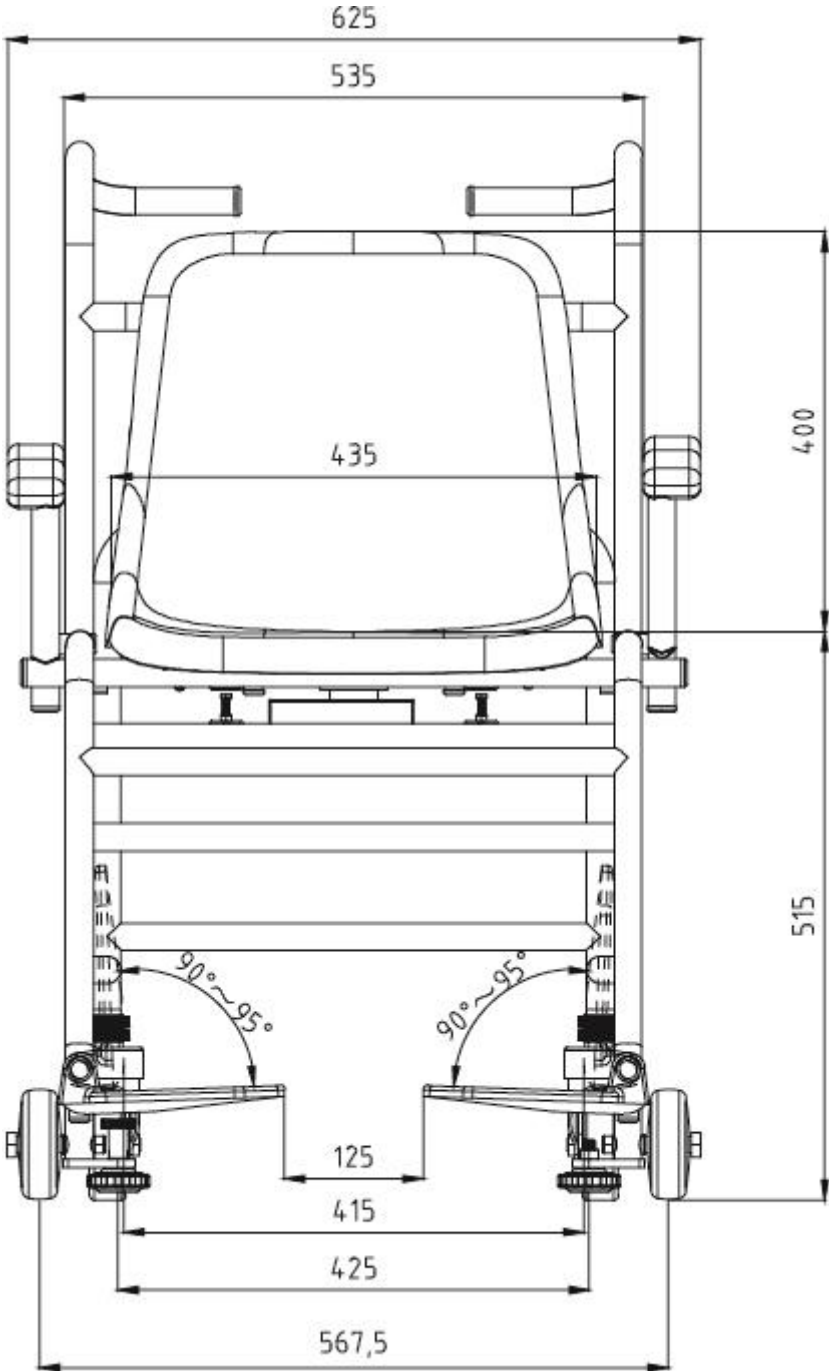

4 Basic Information (General)



Balances have to be verified for the purposes stated below in accordance with Directive 2014/31/EU. Article 1, paragraph 4. "Determination of mass in the practice of medicine that is, weighing patients for reasons of medical supervision during medical surveillance, examination and treatment."

4.1 Specific function

4.1.1 Indication

- Determining the body weight in the medical practice area.
 - Using as „non-automatic balance“
- Place the person carefully in the middle of the seat surface.

Once a steady display value is shown, you can read the weight result.

4.1.2 Contraindication

No contraindication known.

4.2 Proper use

These scales are used to determine weight of people sitting at rest in medical treatment rooms. The scales are suitable for recognizing, preventing and controlling illnesses.



- The person to be weighed should carefully sit down on the center of the seat of the chair scales and remain seated quietly.

Once a steady display value is shown, you can read the weight result. The weighing scale is designed for continuous duty.





The balances shall only be used by people who can sit still.

- The foot rests of the chair scales are fitted with an anti-slip surface that must not be covered during weighing a person.
- The balances should be checked for correct condition prior to each utilization by a person familiar with proper operation of the balance.

	
<ul style="list-style-type: none"> ▪ The chair scales may not be used for the transport of people and objects! ▪ As long as the patient is sitting on the chair scales, the wheel brakes must be locked without fail ▪ The arm rests of the chair scales may only be used to rest the lower arms, not for bracing ▪ When leaving the balance, fold up the arm rests and have the patient braced by a trained person ▪ Install the chair scales always on a level, even surface ▪ Do not step onto the foot rests when stepping or leaving the chair scales! 	

The WIFI interface allows a wireless transfer of the measurement results to a PC.

	<p>Scales fitted with a serial interface may only be connected to appliances in compliance with Directive EN60601-1.</p>
--	--

	<p>If the balance doesn't have any contact with the transfer cable, do not touch the transfer port in order to avoid an ESD-failure.</p> 
---	---

4.3 Non-intended product use / contraindications

	<ul style="list-style-type: none">• Do not use these scales for dynamic weighing processes.• Do not leave permanent load on the weighing pan. This may damage the measuring system.• Impacts and overloading exceeding the stated maximum load (max) of the weighing plate, minus a possibly existing tare load, must be strictly avoided. This could cause damage to the balance.• Never operate the balance in explosive environment. The serial version is not explosion protected. It should be noted that a flammable mixture of anaesthetics and oxygen or laughing gas may occur.• The structure of the balance may not be modified. This may lead to incorrect weighing results, safety-related faults and destruction of the balance.• The balance may only be used according to the described conditions. Other areas of use must be released by KERN in writing.• If the balance is not used for a longer time, take out the batteries and store them separately. Leaking battery liquid could damage the balance.• The balance may only be used for weighing persons. Persons who are heavier than the indicated maximum load, may not step onto the balance.
---	--

4.4 Warranty

Warranty claims shall be voided in case:

- Our conditions in the operation manual are ignored
- The appliance is used beyond the described uses
- Modification or opening of appliances
- Mechanical damage and damage caused by media, liquids,
- Natural wear and tear
- The appliance is improperly set up or incorrectly electrically connected
- The measuring system is overloaded
- Dropping of scales

4.5 Monitoring of Test Resources

In the framework of quality assurance the measuring-related weighing properties of the balances and, if applicable, the testing weight, must be checked regularly. The responsible user must define a suitable interval as well as type and scope of this test. Information is available on KERN's home page (www.kern-sohn.com) with regard to

the monitoring of balance test equipment and the test weights required for this. In KERN's accredited DKD calibration laboratory test weights and balances may be calibrated (return to the national standard) fast and at moderate cost.

4.6 Plausibility check

Please make sure that the measurement values computed by the appliance are plausible and are allocated to the respective patient, before storing and using the values for further purposes. This applies especially also for values transferred via interface.

4.7 Reporting serious incidents



All serious incidents appeared related to this product must be reported to the manufacturer and the responsible authority of the member state where the user and/or the patient are residents.

„Serious incident“ that means an incident which directly or indirectly had, could have or could have had one of the following consequences:

- the death of a patient, a user or another person,
- the temporary or permanent fatal deterioration of the health status of a patient, a user or other persons,
- a serious danger for public health.

5 Basic Safety Precautions

5.1 Pay attention to the instructions in the Operation Manual

	⇒ Carefully read this operation manual before setup and commissioning, even if you are already familiar with KERN balances.	
---	---	---

5.2 Personnel training

The medical staff must apply and follow the operating instructions for proper use and care of the product.

The balance must be set up via the interfaces and integrated into a network only by experienced administrators or hospital technicians.

5.3 Preventing contamination

The prevention of cross-contamination (fungal skin infections,.....) requires regular cleaning of the seating surface.

Recommendation: After any weighing procedure that could potentially result in contamination (e. g. after weighing that involves direct skin contact).

5.4 Preparation for use

- Check the balance for damage before any use
- Maintenance and reverification: The balance must be serviced and reverified at regular intervals.
- Do not use the appliance on slippery surfaces or in facilities with risk of vibration
- During installation the balance must be levelled.
- If possible, the product must remain in its original packaging for transportation purpose. Should this not be possible, make sure that the product is protected against damage
- Step onto and leave the personal balance only when a qualified person is present

6 Electromagnetic compatibility (EMC)

6.1 General hints

This device complies with the limits set for medical electrical devices of group 1, class B (as per EN 60601-1-2). The appliance is suitable for home care, as well as for commercial clinic environment.



The installation and use of this electrical medical device requires special precautionary measures as outlined in the EMC information below.



Do not install the appliance near active surgical high-frequency devices and radio-frequency-shielded rooms of a ME system for magnetic resonance production, where high intensity of electromagnetic interferences occurs.



Do not operate the appliance near or stacked on other appliances as could have as consequence inaccurate measuring results. If such use should be necessary, this appliance and other devices should be observed in order to ensure that they work normally.



The use of accessories, transformers and other cables than the ones specified by the dealer and delivered by him with the device could have as consequence amplified electromagnetic radiation or a weakened resistance against electromagnetic interferences and by that way less functionality.



Portable radiofrequency communication device (incl. periphery, antenna cable and external antennae) should be placed at a distance of at least 30 cm (12 inch) from each part of MWN including the cables admitted by the manufacturer. Otherwise the performance of the appliance could drop down.

Electromagnetic compatibility (EMC) describes a device's ability to perform reliably within an electromagnetic environment without causing inadmissible electromagnetic interference at the same time. Amongst other things, such disturbances may be transmitted by connecting cables or by the air.

Inadmissible interferences from the environment may result in wrong displays, inaccurate measured values or incorrect behavior of the medical device.

By the same token the medical device may in some cases cause such disturbances in other devices. To eliminate problems of that kind, we recommend you to take one or several of the measures listed below:

- Change the alignment or distance of the device to the source of EMI.
- Install or use the balance on another place.
- Connect the balance to another power source.
- For further questions please contact our customer services.

Disturbances may be caused by improper modification or add-ons to the device or not recommended accessories (such as power supply units or connecting cables). The manufacturer will not be responsible for these. Modifications may also result in a loss of authorization relating to the use of the device.



Devices emitting high frequency signals (mobile telephones, radio transmitters, radio receivers) may cause interference in the balance. For that reason do not use them near the balance. Chapter 6.4 contains details about recommended minimum distances.

6.2 Electromagnetic emission of interferences

Guidelines and manufacturer’s declaration – electromagnetic interferences	
The balance is determined for the use in an electromagnetic environment, which complies with the requirements specified below. The customer or user of the medical electrical device must ensure that operation takes place in such an environment.	
Irradiation test	Conformity
Radio irradiation CISPR 11	Assembly 1
Radio irradiation CISPR 11	Class B
Harmonic irradiations IEC 61000-3-2	Category A
Voltage fluctuations/ Flicker irradiation IEC 61000-3-3	Compliance

6.3 Electromagnetic immunity to interferences

Guidelines and manufacturer's declaration - electromagnetic immunity to interferences		
The balance is determined for the use in an electromagnetic environment, which complies with the requirements specified below. The customer or user of the medical electrical device must ensure that operation takes place in such an environment.		
Test for immunity to interference	IEC 60601-1-2 Test level	Matching level
Electrostatic discharge (ESD) IEC 61000-4-2	± 8 kV contact ±2 kV, ±4 kV, ±8 kV, ±15 kV air	± 8 kV contact ±2 kV, ±4 kV, ±8 kV, ±15 kV air
Electrical quick transient / Burst IEC 61000-4-4	± 2 kV for power cables ± 1 kV Signal input/output 100 kHz repeated frequency	± 2 kV for power cables ± 1 kV Signal input/output 100 kHz repeated frequency
Excess voltage IEC 61000-4-5	±0.5 kV, ±1 kV differential mode ±0.5 kV, ±1 kV, ±2 kV General mode	±0.5 kV, ±1 kV differential mode ±0.5 kV, ±1 kV, ±2 kV General mode
Drops of voltage, short interruptions and voltage fluctuations on power feeding lines IEC 61000-4-11	0 % UT; 0.5 cycle. At 0°, 45°, 90°, 135°, 180°, 225°, 270° and 315°. 0 % UT; 1 cycle and 70 % UT; 25/30 cycles; single phase: at 0°. 0 % UT; 250/300 cycle	0 % UT; 0.5 cycle. At 0°, 45°, 90°, 135°, 180°, 225°, 270° and 315°. 0 % UT; 1 cycle and 70 % UT; 25/30 cycles; single phase: at 0°. 0 % UT; 250/300 cycle
Power frequency magnetic field IEC 61000-4-8	30 A/m 50Hz / 60Hz	30 A/m 50Hz / 60Hz
Guided radio frequency IEC61000-4-6	3 V 0.15 MHz – 80 MHz 6 V in ISM and amateur radio strip widths between 0.15 MHz and 80 MHz 80 % AM and 1 kHz	3 V 0.15 MHz – 80 MHz 6 V in ISM and amateur radio strip widths between 0.15 MHz and 80 MHz 80 % AM and 1 kHz
Irradiation radio frequency IEC61000-4-3	10 V/m 80 MHz – 2.7 GHz 80 % AM and 1 kHz	10 V/m 80 MHz – 2.7 GHz 80 % AM and 1 kHz
NOTE	U_T equals AC mains voltage prior to application of test level.	

Guidelines and manufacturer's declaration - electromagnetic immunity to interferences

Irradiation radio frequency	Test Frequency (MHz)	Strip (MHz)	Service	Modulation	Max. intensity (W)	Distance (m)	IEC 60601-1-2 Test level (V/m)	Matching level (V/m)
IEC61000-4-3 (Test Specification for appendix port immunity to interference to wireless radio-frequency communication plant)	385	380 –390	TETRA 400	Pulse modulation 18 Hz	1,8	0.3	27	27
	450	430 –470	GMRS 460, FRS 460	FM ± 5 kHz deviation 1 kHz sine	2	0.3	28	28
	710	704 – 787	LTE strip 13, 17	Pulse modulation 217 Hz	0,2	0.3	9	9
	745							
	780							
	810	800 – 960	GSM 800/900, TETRA 800, iDEN 820, CDMA 850, LTE strip 5	Pulse modulation 18 Hz	2	0.3	28	28
	870							
	930							
	1720	1 700 – 1 990	GSM 1800; CDMA 1900; GSM 1900; DECT; LTE strip 1, 3, 4, 25; UMTS	Pulse modulation 217 Hz	2	0.3	28	28
	1845							
	1970							
	2450	2 400 – 2 570	Bluetooth WLAN 802.11 b/g/n, RFID 2450, LTE strip 7	Pulse modulation 217 Hz	2	0.3	28	28
	5240	5 100 – 5 800	WLAN 802.11 a/n	Pulse modulation 217 Hz	0,2	0.3	9	9
	5500							
5785								

6.3.1 Crucial features of performance

	<p>The balance does not have any crucial features of performance as per IEC 60601-1. The system may be subject to interference by other devices even if these devices conform to current emission requirements as per CISPR.</p>
---	--

6.4 Minimum distances

Recommended safety distances between portable and mobile HF telecommunication devices and the medical device			
<p>This balance is designed for use in an electromagnetic environment in which high-frequency disturbance variables are controlled. The customer or user of the medical electrical device can help avoiding electromagnetic disturbances by keeping the minimum distance between portable and mobile HF telecommunication devices (transmitters) and the balance – depending on the output performance of the communication device, as stated below.</p>			
Rated capacity of transmitter %W	The safety distance depends on the transmission frequency m		
	150 kHz to 80 MHz $d = 1.2\sqrt{P}$	80 MHz to 800 MHz $d = 1.2\sqrt{P}$	800 MHz to 2.5 GHz $d = 2.3\sqrt{P}$
0.01	0.12	0.12	0.23
0.1	0.38	0.38	0.73
1	1.20	1.20	2.30
10	3.80	3.80	7.30
100	12.00	12.00	23.00
<p>For transmitters with a maximum rated capacity not stated in the table above you can calculate the recommended safety distance in meters (m) yourself by using the equation belonging to the respective column, whereby P equals the maximum rated capacity of the transmitter in Watt (W) as per details provided by the transmitter manufacturer.</p> <p>NOTE 1 Higher frequency range applies to 80 MHz and 800 MHz. NOTE 2 These guidelines may not be applicable in all cases. The spread of electromagnetic variables is influenced by absorption and reflections in buildings, objects and persons.</p>			

7 Transport and storage

7.1 Testing upon acceptance

When receiving the appliance, please check packaging immediately, and the appliance itself when unpacking for possible visible damage.

7.2 Packaging / return transport



- ⇒ Keep all parts of the original packaging for a possibly required return.
- ⇒ Only use original packaging for returning.
- ⇒ Prior to dispatch disconnect all cables and remove loose/mobile parts.
- ⇒ Reattach possibly supplied transport securing devices.
- ⇒ Secure all parts against shifting and damage.

8 Unpacking, Installation and Commissioning

8.1 Installation Site, Location of Use

The balances are designed in a way that reliable weighing results are achieved in common conditions of use.

You will work accurately and fast, if you select the right location for your balance.

On the installation site observe the following:

- Place the balance on a stable, even surface
- Avoid extreme heat as well as temperature fluctuation caused by installing next to a radiator or in the direct sunlight
- Protect the balance against direct draughts due to open windows and doors
- Avoid jarring during weighing
- Protect the balance against high humidity, vapours and dust
- Do not expose the device to extreme dampness for longer periods of time. Non-permitted condensation (condensation of air humidity on the appliance) may occur if a cold appliance is taken to a considerably warmer environment. In this case, acclimatize the disconnected appliance for ca. 2 hours at room temperature.
- Avoid static charge of the balance and of the person to be weighed
- Avoid contact with water.

Major display deviations (incorrect weighing results) may be experienced, should electromagnetic fields (e.g. due to mobile phones or radio equipment), static electricity accumulations or instable power supply occur. Change location or remove source of interference.

8.2 Unpacking

Remove the individual components of the balance or the complete balance from the packaging with care and install at the intended location. When using the power supply unit, ensure that the power cable does not produce a risk of stumbling.

8.3 Scope of delivery

- Balance
- Mains adapter (in conformity with EN 60601-1)
- Battery function (batteries not included)
- Protective hood
- Operating instructions

8.4 Installing the chair scales

Carefully remove the balance from the packaging, remove plastic cover and setup balance at the intended workstation.

Levelling:



- ⇒ Place scales on an even surface.
- ⇒ Check if the air bubble of the level is within the prescribed circle.

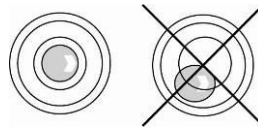

- ⇒ If the air bubble of the bobble level is **not** in the required circle, level the balance using the adjustment feet as specified in the following chapter 8.4.1:
- ⇒ Check levelling regularly



Once installation is complete, check all screws for tight fit. Otherwise the person to be weighed may suffer injury.

8.4.1 Levelling



Levelling is restricted to specialist staff possessing well acquainted with the workings of weighing scales.

- ⇒ Place scales on an even surface.
- ⇒ Lock brakes



⇒ Turn the wheel (1) until the air bubble of the bubble level is in the black circle

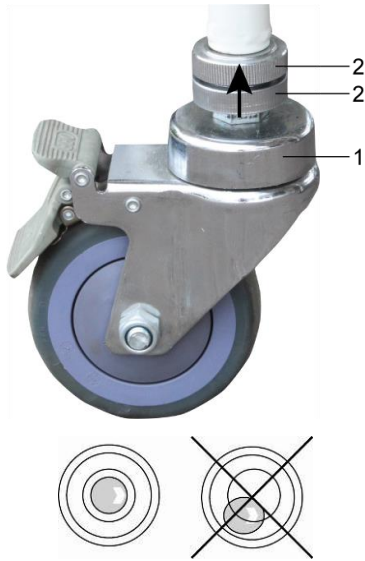

⇒ Turn the counter nuts (2) right to the top.



Gap width must not exceed 15 mm!

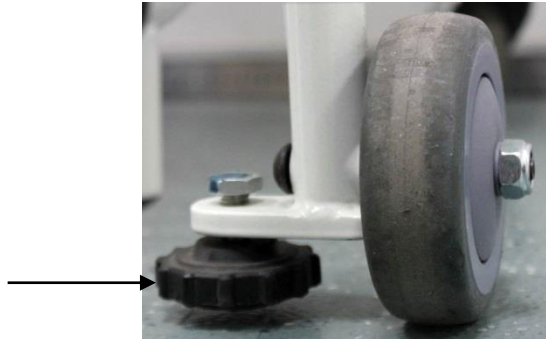



⇒ Use the adjustment feet to fix the chair at the front rollers

8.5 Battery operation

As an alternative for the rechargeable battery operation, the balance offers also the possibility to be operated with 6x AA-batteries.

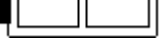
Open the battery cover (1) at the lower side of the display unit and insert the batteries according to the example shown below. Lock again the battery compartment cover. If

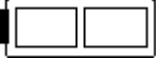
the batteries are exhausted, the symbol  and „Lo bAt“ is displayed on the balance; replace the batteries. To save the battery, the balance switches automatically off (see chap. 9.5 Auto off).

 + Lo bAt	Capacity of batteries exhausted.
	Capacity of batteries will soon be exhausted.
	Batteries completely charged

Disclaimer:

Only use KERN type rechargeable battery YMR-01 (RC 193650) or batteries AA 1.5 V (6x). Other may cause damages to the product, which can lead to injuries of persons

	If the balance is not used for a longer time, take out the batteries and store them separately. Leaking battery liquid could damage the balance.
---	--

	Replacement for rechargeable battery by inadequately trained personnel could result in a hazard
---	---

Insert batteries:

Remove the battery compartment cover at the side of the display unit (1)



Remove the battery holder (2)

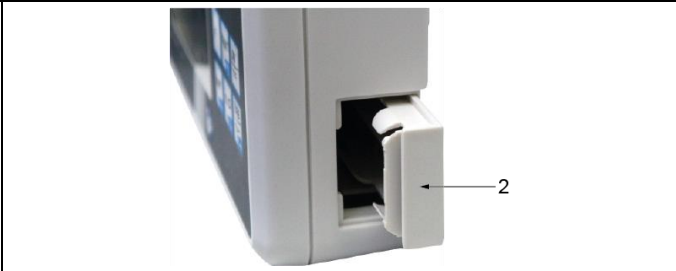

Insert the batteries into the battery holder



Insert batteries with the battery holder into the battery compartment and lock it with battery compartment cover.



Insert batteries in the battery compartment and lock them with battery compartment cover.







8.6 Rechargeable battery operation using an optional battery power pack

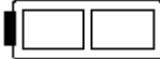

Open the battery compartment cover (1) at the base of the display unit and insert the rechargeable battery. Charge the rechargeable battery for at least 12 hours before initial use.

The appearance of the symbol  in the weight display indicates that the rechargeable battery is almost exhausted. The weighing scale will remain ready for operation for a few more minutes before switching off automatically in order to save the rechargeable battery (see chap. 9.5 Auto off). Charge rechargeable battery.

	Voltage has dropped below prescribed minimum
	Rechargeable battery very low
	Rechargeable battery completely recharged

	<ul style="list-style-type: none"> • If the rechargeable battery is exhausted, „LobAt“ is displayed. The rechargeable battery is charged via the provided plug-in power supply unit (charging time 12 h for a complete charging). • If the balance is not used for a longer time, take out the rechargeable battery and store it separately. Leaking liquid could damage the balance.
---	---

8.7 Mains connection

Power is supplied by the external mains adapter which also serves to isolate the mains supply from the scale. The stated voltage value must be the same as the local voltage. Only approved genuine KERN mains adapters may be used in compliance with Directive EN 60601-1.

The small sticker attached to the side of the display unit indicates the power port:

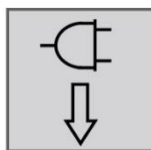

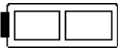
If the symbol  appears in the display, the rechargeable battery will soon be exhausted. Connect the power supply unit and charge the rechargeable battery.

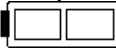
The flashing symbol  informs you during charging about the charging status of the rechargeable battery.

8.7.1 Safety cable

Safety cable for strain relief of the mains cable.

(cable length incl. Mains cable less than 3 m)



Application:

Installation for strain relief between mains cable (plug-in power supply unit) and display unit.

8.8 Initial Commissioning

In order to obtain exact weighing results with the electronic balances, your balance must have reached the operating temperature (see warming up time chap.1). During this warming up time the balances must be connected to the power supply (mains, accumulator or battery) and be switched on.

The accuracy of the balance depends on the local acceleration of gravity. The value of gravity acceleration is shown on the type plate.

9 Operation

After the balance having been transported to the patient, the balance must be levelled prior to weighing, see graphic below.

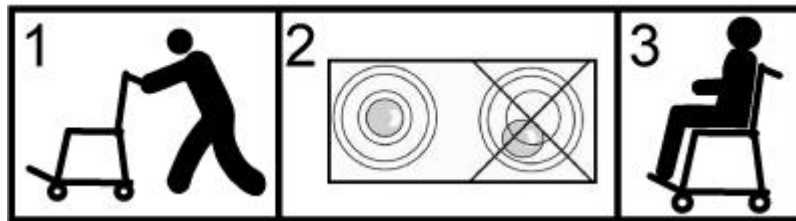



Step onto and leave the balance

Step onto and leave the chair scales only when a qualified person (see chap. 5.2) is present

9.1 Weighing

	<p>⇒ Start balance by pressing .</p> <p>The balance will carry out a self-test The balance is ready for operation as soon as the weight display "0.0 kg" appears.</p>
--	--



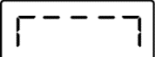

	<p>▪ However, you can reset the weighing scale to zero by pressing  the  key.</p>
--	---

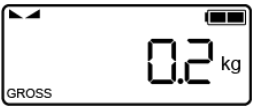
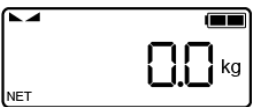

- ⇒ Have person sit in the center of the scales.
- ⇒ Fold the footrests and the arm rests downwards. Put both feet of the patient on the respective foot rest.
- ⇒ Put the lower arms of the patient on the arm rests.
- ⇒ Wait for the rest position display , then read the weighing result.
- ⇒ Once the weighing process is completed fold up the foot- and arm rests.

	<p>▪ If the person is heavier than the weighing range,  (=overload) will appear in the display.</p>
--	--

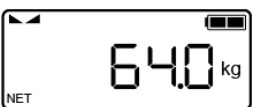
9.2 Taring

The tare weight of any preloads can be deducted by pressing a button so that the actual weight of the person is displayed in subsequent weighings.

 <p>(example)</p>	<p>⇒ Put object (such as towel or padding) on the seating pan.</p>
	<p>⇒ Press , the zero display appears.</p> <p>⇒ „NET” is shown at the bottom on the left.</p>
 <p>(example)</p>	<p>⇒ Seat person in the center of the seat pan. Wait until the stability display  appears, then read the weighing result.</p>

	<ul style="list-style-type: none"> ▪ When the balance is unloaded the saved taring value is displayed with negative sign. ▪ To delete the stored tare value, unload the balance and press .
---	--











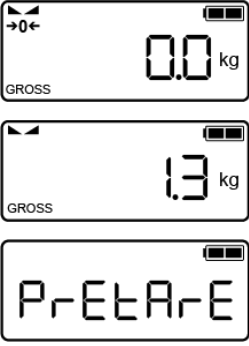

9.2.1 Subsequent tare weight

The balance can be tared several times successively.















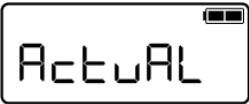

9.2.2 Pretare

The possibility exists to enter either a known pre-tare value via the keyboard or to store the weight of an object placed on the weighing plate as a pre-tare value.

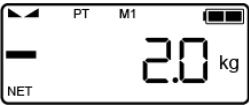

Store the weight of an object placed on the weighing plate:

	<p>⇒ Start balance by pressing . Wait for stability display .</p> <p>⇒ Place the object whose weight shall be stored as a pre-tare value, on the seat pan. (in this example „1.3 kg“)</p> <p>⇒ Press  and keep pressed, the application menu is called up. „ApcMen“, followed by „WghMod“ is displayed. Then „PtArE“ appears automatically.</p>
	<p>⇒ Acknowledge by , „ActuAL“ will be shown.</p>
	<p>⇒ Acknowledge by , in the display „PT“ and „M1“ appear flashing.</p> <p>⇒ Now select the desired memory location between 1 and 4 using the -key.</p>
	<p>⇒ Press  again, „ActuAL“ appears anew, „PT“ and „M1“ stop flashing.</p>
	<p>⇒ Press  again, „Wait“ appears shortly, the weight placed on the weighing plate at this moment, will be taken over as pre-tare value. The scales will change to zero display. „NET“ appears.</p>

Enter the pre-tare value manually via the keyboard:







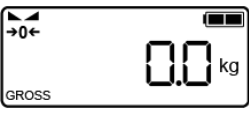

 	<p>⇒ Start balance by pressing . Wait for stability display .</p> <p>⇒ Press  and keep pressed, the application menu is called up. „ApcMen“, followed by „WghMod“ is displayed. Then „PtArE“ appears automatically.</p>
	<p>⇒ Acknowledge by  , in the display „PT“ and „M1“ appear flashing.</p> <p>⇒ Now select the desired memory location between 1 and 4 using button .</p>
	<p>⇒ Press  again, „ActuAL“ is displayed.</p>
	<p>⇒ Press  , "ManuAL" is displayed.</p>
	<p>⇒ Press  , the display to enter the pre-tare value appears flashing. Enter numeric values using  and  , press  to change over to the next decimal digit and finally acknowledge the entered value.</p> <p>The balance changes into the weighing mode, the entered pre-tare value is displayed with a minus as a negative value.</p>

Delete pre-tare value:

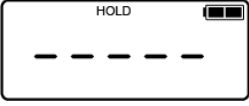
- Unload the weighing plate and press , the balance goes to zero display.
- Or after adjustment „ManuAL“ press , „cLEAR“ appears. After that press , the pre-tare value is deleted.

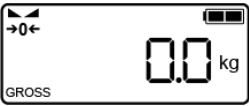











9.3 HOLD function

The balance has an integrated standstill function (mean value calculation). This allows correct weighing determination of a person although the latter is not keeping still on the seat surface.

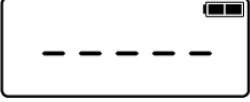
	<p>⇒ Start balance by pressing . Wait for stability display .</p>
  (example) 	<p>⇒ Press , in the display „-----“ will appear and the „HOLD“ symbol appears flashing.</p> <p>⇒ During this display place the person in the middle of the seat surface.</p> <p>⇒ As soon as the „HOLD“-symbol does not more flash and the stability display  appears, the weighing value of the person will be displayed and „frozen“.</p> <p>After unloading the balance, the weighing value remains displayed for approx. 10 seconds, the „HOLD“ symbol appears flashing during that time. Then the balance returns automatically into the weighing mode. The „HOLD“ symbol goes out, and the zero display appears.</p>
	<p>There is no average value calculation in the event of too much movement.</p>

9.4 Calculation of the Body Mass Index

You need to know a person's body height before you can calculate the BMI for that person. This should be known.

 	<p>⇒ Start balance by </p> <p>⇒ Wait for stability display  .</p> <p>⇒ Press  . The most recently entered body height will be shown in centimeters, the enabled digit flashes.</p>
   	<p>⇒ To enter body height, press the buttons  and  .</p> <p>⇒ Confirm the value entered with  . „StEPon“ is displayed</p> <p>⇒ Seat person in the center of the seat pan. „-----“, appears shortly, followed by the person's BMI value. The "BMI" symbol appears.</p>
	<p>⇒ Relief the seat pan</p> <p>⇒ The balance returns automatically to the weighing mode; the „BMI“ symbol goes out, the zero display appears.</p>

	<ul style="list-style-type: none"> • Reliable calculation of BMI is restricted to a body height of 100 cm to 200 cm and a weight of >10 kg. • If weighing has to take place under unsteady conditions, you can be stabilise the display by applying the Hold function.
---	---

9.4.1 Classification of BMI values

Weight classification for adults over 18 years of age using the BMI in accordance with WHO, 2000 EK IV and WHO 2004.

Category	BMI (kg/m ²)	Risk of diseases associated with overweight
Underweight	< 18.5	Low
Normal weight	18.5 – 24.9	Average
Overweight	≥ 25.0	A bit increased Increased High Very high
Pre-adipose	25.0 – 29.9	
Adipose degree I	30.0 – 34.9	
Adipose degree II	35.0 – 39.9	
Adipose degree III	≥ 40	

9.5 Automatic switch-off function „AUTO OFF“

The weighing scale will switch off automatically after the allotted time as long as neither the display unit nor the weighing surface is operated.

⇒ In weighing mode press simultaneously, „SetuP“ followed by „coM“ will appear.

⇒ Press repeatedly until „AutoFF“ appears.





⇒ Press , "ModE" is displayed

⇒ Press again, „onLY0“ is displayed
Here you can select between these settings:
onLY0: Auto Off only with zero display
oFF: Auto Off switched off
Auto: Auto off independent on the load on the balance

⇒ Select the required setting by and acknowledge on

⇒ Press repeatedly until the zero display appears. The balance is now in weighing mode







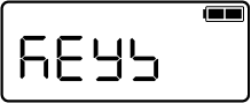

To set a determined switch-off time, proceed as follows:

	⇒ As described above, call-up the menu item „ModE“
	⇒ Press  , „tIME“ appears, acknowledge on  , select the required setting by  :
[2 min]	Weighing system will be turned off after 2 min.
[5 min]	Weighing system will be turned off after 5 min.
[30 min]	Weighing system will be turned off after 30 min.
[60 min]	Weighing system will be turned off after 60 min.
[30 S]	Weighing system will be turned off after 30 sec.
[1 min]	Weighing system will be turned off after 1 min.
<p>(example)</p>	⇒ Confirm selected time with  and return to weighing mode using  .

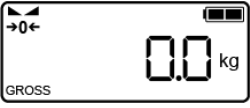
9.6 Signal tone when pressing button

The balance offers the possibility to switch off or on an acoustic signal by pressing the keys.











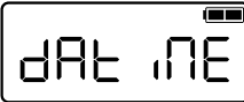
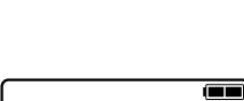





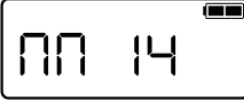
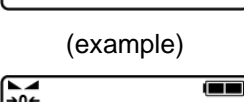

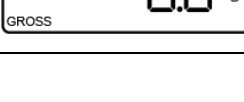
	<ul style="list-style-type: none">• Menu settings: [bEEPEr] ⇨ [KEYS – on/oFF]
---	---

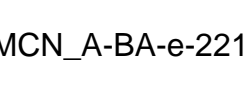
   (example) 	<p>⇨ In menu call-up the menu item „bEEPEr“</p> <p>⇨ Press  „KEYS“ is displayed</p> <p>⇨ Press  again, the last saved setting will be displayed. Here as example “OFF”</p> <p>⇨ Select desired setting with  and acknowledge by .</p> <p>⇨ Press  repeatedly until the zero display appears. The balance is now in weighing mode</p>
---	---

9.7 Setting time and date

(only available with Real Time Clock)









	<ul style="list-style-type: none"> • Menu settings: [dAtIME]
---	---

 <p>(example)</p>	<p>Setting date:</p>
 <p>(example)</p>	<p>⇒ In menu call-up the menu item „dAtIME“</p>
 <p>(example)</p>	<p>⇒ Press  repeatedly until the prompt for entering the year appears „YY20xx“. Enter the current year with  or </p>
 <p>(example)</p>	<p>and confirm by .</p>
 <p>(example)</p>	<p>⇒ The display changes automatically to the prompt for entering the month: „MM xx“</p>
 <p>(example)</p>	<p>⇒ Enter the current month with  or  and confirm by</p>
 <p>(example)</p>	<p>.</p>
 <p>(example)</p>	<p>⇒ The display changes to the prompt for entering the day: „dd xx“. Enter the current day with  or  and</p>
	<p>confirm by .</p>
	<p>Setting time:</p>
	<p>⇒ Now the display changes automatically to the prompt for entering the time, first the hour: „hh xx“.</p>
	<p>⇒ Enter the hour with  or  and confirm by .</p>
	<p>⇒ The minutes appear: „MM xx“. Enter the current minutes and</p>
	<p>confirm on .</p>
	<p>⇒ The seconds appear: „SS xx“. Enter the seconds and</p>
	<p>confirm on .</p>
	<p>⇒ Date and time have now been entered; the display changes to the weighing mode.</p>

10 Menu

	<p>Access to service menu „tCH“ is locked in verified balances.</p> <p>To disable the access lock, destroy the seal mark and actuate the adjustment switch. For position of adjustment switch, see chap. 18.1.</p> <p>Attention:</p> <p>After destruction of the seal mark the weighing system must be re-verified by an authorised agency and a new seal mark fitted before it can be reused for applications subject to verification.</p>
---	--

10.1 Navigation in the menu

<p>Call up menu</p>	<p>⇒ In weighing mode press   simultaneously, „SetuP“ followed by „coM“ will appear.</p>
<p>Select function</p>	<p>⇒ With help of  or , the individual functions can be selected one after the other.</p>
<p>Change settings</p>	<p>⇒ Confirm selected function by . The current setting will be displayed.</p> <p>⇒ Select desired setting with   and confirm by , the balance returns to the menu.</p>
<p>Exit menu/ Return to weighing mode</p>	<p>⇒ Press  repeatedly until the zero display appears. The balance is now in weighing mode.</p>

10.2 Menu overview

Menu block Main menu	Menu item Submenu	Available settings / explanation	
SEtuP			
coM Interface parameter	rS232	RS232 mode	
	bAUd	Baud rate 9600, 14400, 19200, 38400, 57600, 115200, 128000, 256000, 600, 1200, 2400, 4800	
	dAtA	Data bits: 8dbitS, 7dbitS	
	PAritY	Parity nonE, odd, EVEn	
	StoP	Stop bits: 1Sbit, 2SbitS	
	HAndSh	Handshake: nonE	
	Protoc	Communication Protocol: KCP,	
	uSb-d	USB interface	
	bAud	Baud rate 9600, 14400, 19200, 38400, 57600, 115200, 128000, 256000, 600, 1200, 2400, 4800	
	dAtA	Data bits: 8dbitS, 7dbitS	
	PAritY	Parity nonE, odd, EVEn	
	StoP	Stop bits: 1Sbit, 2SbitS	
	HAndSh	Handshake: nonE	
	Protoc	Communication Protocol: KCP,	
	WLAN	WLAN interface: on, oFF	
	Print Printer settings	intFcE	Interface
		rS232	RS232 interface
		uSb-d	USB interface
		PrModE	Printer settings
MAnUAL		The weighing value is printed out when pressing 	
Auto		The weighing value is automatically printed out	
cont		Continuous data output	
ForMAt		long , short	
LAYout	USEr		

bEEPEr Signal tone	KEYS		Signal tone when pressing button
		on	Acoustic signal on
		oFF	Acoustic signal off
AutoFF Automatic switch-on function	Mode		Settings autom. switch-off function
		oFF	Automatic switch-off function switched off
		Auto	Automatic switch-off independent on the load on the balance
		onLY0	Automatic switch-off only with zero display
	timeE		Setting the switch-off time
	30 S, xMin	Automatic switch off after: 30 sec, 1 min, 2 min, 5 min, 30 min, 60 min	
dAt iME Date and time			Setting date and time
		YY.2021	Setting date: Year
		MM 06	Month
		dd 22	Date
		hh 11	Setting time: Hour
		MM 53	Minutes
		SS 33	Seconds
rESEt back to default setting		Balance is reset to default setting	

11 Communication with peripheral devices via KUP connection

Via the interfaces weighing data may be exchanged with connected peripheral devices. Issue may be made to a printer, PC or check displays. In reverse order, control orders and data inputs may be made via the connected devices.

The balances of the TMCN series are equipped with a KUP connection (KERN Universal Port) as per standard.

The following options are available as interfaces:

	Interface adapter with cable	
	Model	Example for application
RS232	YKUP-01	Serial printer
USB	YKUP-03	PC
Ethernet	YKUP-04	PC
Bluetooth	YKUP-06	Android terminal unit or PC
Kern Extension Box	YKUP-13	Several interfaces in parallel

i	The available interfaces can be used via the KUP (YKUP-13) in parallel manner.
----------	--

Additional equipment connected to medical electrical equipment must comply with the respective IEC or ISO standards (e.g. IEC 60950 for data processing equipment). Furthermore all configurations shall comply with the requirements for medical electrical systems (See IEC 60601-1 or clause 16 of the 3Ed. of IEC 60601-1, respectively). Anybody connecting additional equipment to medical electrical equipment configures a medical system complies with the requirements for medical electrical systems. Attention is drawn to the fact that local laws take priority over the above mentioned requirements. If in doubt, consult your local representative or the technical service department.

Connector assignment balance:

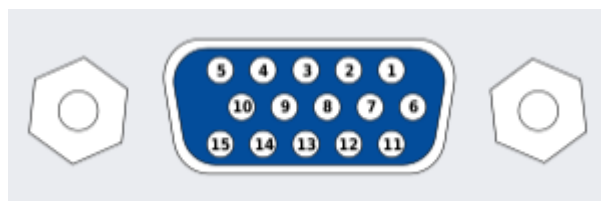

Warning: Only for use with KUP interfaces

	Externally attached third party interface cables, which are connected to the KUP interfaces, may not exceed 10 m in length.
--	---

11.1 KERN Communications Protocol (KERN Interface Protocol)

KCP is a standardized set of interface orders for KERN balances, which allows many parameters and device functions to be called up and controlled. KERN devices that have KCP can use it to connect easily to computers, industrial control systems and other digital systems. A detailed description you will find in the „KERN Communications

Protocol“ manual, available in the download area on our KERN homepage (www.kern-sohn.com).

To activate KCP please observe the menu overview of your balance’s operating instructions.

KCP is based on simple ASCII orders and replies. Every interaction consists of an order, possibly with arguments separated by spaces and finished by <CR><LF>.

The KCP orders supported by your balance may be queried emitting the order „I0“ followed by CR LF.

Extract of the mostly used KCP orders:

I0	Shows all implemented KCP orders
S	Sending stable value
SI	Sending current value (also instable)
SIR	Sending current value (also instable) and repeating
T	Taring
Z	Zeroing

Example:

Order	S	
Possible replies	S_ S_... 100.00_g S_ I S_+ or S_-	Order accepted, execution of the order started, currently another order is executed, timeout reached, over- or underload

11.2 Data output after pressing the PRINT button < manual >

Activate function:

- ⇒ In Setup menu invoke the menu setting < P r i n t → P r o d E > and confirm with button →.
- ⇒ For a manual data output select the menu setting < M A N U A L > with the navigation keys ↓↑ and confirm on the → button.
- ⇒ Use the navigation keys ↓↑ to select the setting < o n > and confirm on → button.
- ⇒ To exit the menu press the navigation key ← repeatedly.

Place goods to be weighed on balance:

- ⇒ If required, place empty container on scale and tare.
- ⇒ Place goods to be weighed. The weighing value is edited by pressing the PRINT-button.

11.3 Automatic data output < auto>

Data output happens automatically without having to press the **PRINT**-key as soon as the corresponding output condition has been met, dependent on the setting in the menu.

Enable function and set the output condition:

- ⇒ In Setup menu invoke the menu setting < PRINT → PrMODE > and confirm with button →.
- ⇒ For an automatic data output select the menu setting < AUTO > using the navigation keys ↓↑ and confirm by the → button.
- ⇒ Use the navigation keys ↓↑ to select the setting < ON > and confirm on → button. < PrMODE > is displayed.
- ⇒ Acknowledge by →-button and set the required output condition with the navigation keys ↓↑.
- ⇒ Acknowledge by →-button.
- ⇒ To exit the menu press the navigation key ← repeatedly.

Place goods to be weighed on balance:

- ⇒ If required, place empty container on scale and tare.
- ⇒ Place weighed goods and wait until the stability display (▲▲) appears. The weighing value is issued automatically.

11.4 Continuous data output < cont >

Enable function and set the output interval:

- ⇒ In Setup menu invoke the menu setting < PRINT → PrMODE > and confirm on → button.
- ⇒ For a continuous data output select the menu setting < CONT > using the navigation keys ↓↑ and confirm on → button.
- ⇒ Use the navigation keys ↓↑ to select the setting < ON > and confirm on → button.
- ⇒ < SPEED > is displayed.
- ⇒ Acknowledge by →-button and set the required time interval using the navigation keys ↓↑.
- ⇒ To exit the menu press the navigation key ← repeatedly.

Place goods to be weighed on balance

- ⇒ If required, place empty container on scale and tare.
- ⇒ Place goods to be weighed.
- ⇒ The weighing values are issued according to the defined interval.

Sample log (KERN YKB-01N):

S	D	1.9997	kg
S	D	1.9999	kg
S	D	1.9999	kg
S	D	1.9999	kg
S	S	2.0000	kg
S	S	2.0000	kg
S	S	2.0000	kg
S	S	2.0000	kg
S	D	1.9998	kg
S	D	1.9999	kg
S	D	2.0002	kg
S	D	2.4189	kg
S	D	2.9998	kg
S	D	2.9996	kg
S	D	2.9996	kg
S	D	2.9997	kg
S	D	2.9997	kg
S	S	2.9996	kg
S	S	2.9996	kg

	<p>The balances which have a serial interface, may only be connected to electrical office machines.</p>
---	---

11.5 Data format

- ⇒ In Setup menu invoke the menu setting `<Print → PrintE>` and confirm with button `→`.
- ⇒ Use the navigation keys `↓↑` to select the menu setting `<Format>` and confirm on `→` button.
- ⇒ Use the navigation buttons `↓↑` to select the desired setting.
Options:
 - `<Short>` Standard measuring protocol
 - `<Long>` Detailed measuring protocol
- ⇒ Confirm setting with `→`-button.
- ⇒ To exit the menu press the navigation key `←` repeatedly.

Sample log (KERN YKB-01N):

Format → Short		Format → Long	
N:	S S	2.0000 kg	
T:		0.5000 kg	
G:		2.5000 kg	

11.6 WLAN

- W-LAN standard: IEEE 802.11 b/g/n (Wi-Fi)
- Network log: TCP/IP with DHCP
- Supported encryption methods: WPA, WPA2
- Transmission frequency: 2412 - 2472 MHz
- Maximum transmission performance: < 20dBm
- Application log: KCP (KERN Communications Protocol):

Set up WIFI connections:

1. The balance creates a WIFI access point as soon as it has started up (WLAN symbol in the balance display appears).
Use your computer to connect to this access point.
The SSID (name of the balance's access point) is „AI_THINKER_xxxxxx“
2. Using a web browser visit the website <http://192.168.4.1/> .
In the website:
 - A. Set the mode „Mode“ to “apsta”
 - B. Enter information about the network which you want to integrate the balance into (network „AP Name“ and password „AP Password“)
 - C. Save the settings „Save“ and update the site

ESP8266 WebConfig Restore Reboot

Serial Setting	SoftAP	Station
Baud: 115200	SSID: AI-THINKER_872B77	Mode: apsta
Databits: 8	Passwd:	AP Name: YKV_Net
Parity: NONE	Auth Mode: OPEN	AP Password: YKV123456
Stopbits: 1	IP addr: 192.168.4.1	IP address: 0.0.0.0
	Subnet mask: 255.255.255.0	Subnet mask: 0.0.0.0
	Gateway: 192.168.4.1	Gateway: 0.0.0.0
	Mac: be:dd:c2:87:2b:77	Mac: bc:dd:c2:87:2b:77

A
B
C

3. Separate the access point from the computer
4. Cut the power supply to the balance for a short moment
5. Connect the computer again to the access point of the balance and update the website
 - D. Now the IP-address „IP address“ is displayed

ESP8266 WebConfig Restore Reboot

Serial Setting	SoftAP	Station
Baud: 115200	SSID: AI-THINKER_872B77	Mode: apsta
Databits: 8	Passwd:	AP Name: YKV_Net
Parity: NONE	Auth Mode: OPEN	AP Password: YKV123456
Stopbits: 1	IP addr: 192.168.4.1	IP address: 192.168.132.32
	Subnet mask: 255.255.255.0	Subnet mask: 255.255.255.0
	Gateway: 192.168.4.1	Gateway: 192.168.132.1
	Mac: be:dd:c2:87:2b:77	Mac: bc:dd:c2:87:2b:77

D

6. Close the website
7. Connect the computer to the selected network
8. Enter the IP / Port into the target software: 23

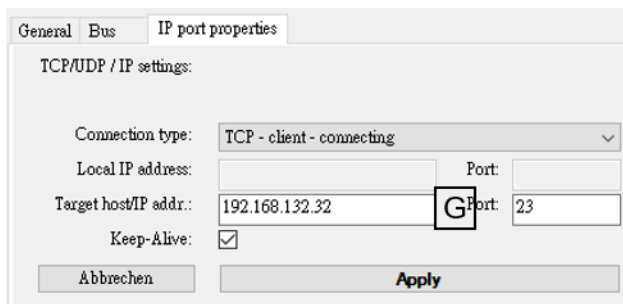

11.7 Print function

After a correct connection of the software and the balance, the weighing data can be transferred using the button  on the balance.

12 Bluetooth

The balance is optionally available with **Bluetooth Low Energy** (BLE) and will then be visible to Bluetooth Master devices using its serial number.

To access this, please use an appropriate software program / app which supports Bluetooth Low Energy (BLE). Applications exclusively using Bluetooth Classic (BLC) will not work.

The following profile must be adjusted:

Service UUID
0000fff0-0000-1000-8000-00805f9b34fb

Read characteristic UUID
0000fff1-0000-1000-8000-00805f9b34fb

Write characteristic UUID
0000fff2-0000-1000-8000-00805f9b34fb







- Transmission frequency: 2402 - 2480 MHz
- Maximum transmission performance: < 20dBm

13 Alibi memory (optional)

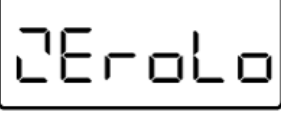

The balance stores weighing data after pressing  in the alibi memory. They can be retrieved from there at any time.

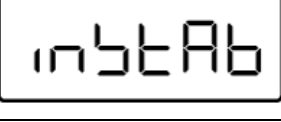
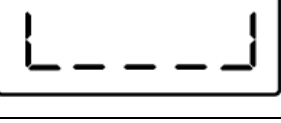
14 Error messages

Display	Description
	Battery capacity exhausted
	Battery capacity soon exhausted
	Zero setting range exceeded
	Zero setting range not achieved
	Adjustment error
	Load instable
	Underload
	Overload

Should other error messages occur, switch balance off and then on again. If the error message remains inform manufacturer.

15 Servicing, maintenance, disposal

15.1 Cleaning

	Before any maintenance, cleaning and repair work disconnect the appliance from the operating voltage.
---	---

15.2 Cleaning / disinfecting

Clean weighing platform (such as seat) as well as casing with household detergents or commercially available disinfectants, e.g. 70% isopropanol. We recommend a disinfectant suitable for wiping disinfection. Please follow manufacturer's instructions.

Do not use abrasive or aggressive cleaners such as spirits or alcohol or similar as they might damage the high-quality surface.

To prevent cross-contamination (fungal skin infection) please observe the following time intervals for disinfection:

- Weighing plate before and after any measurement with direct skin contact
- When required:
 - Display
 - Touch-sensitive keyboard

	Do not spray the device with disinfectant, just wipe it. Make sure that disinfectant does not penetrate the interior of the balance. Remove dirt immediately.
---	---

15.3 Sterilisation

Sterilisation of the appliance not allowed.

15.4 Servicing, maintenance

The appliance may only be opened by trained service technicians who are authorized by KERN.

We recommend a regular safety-related technical check (STK).

Disconnect scales from mains before opening.

15.5 Disposal

Disposal of packaging and appliance must be carried out by operator according to valid national or regional law of the location where the appliance is used.

16 Instant help for troubleshooting

In case of a fault in the program sequence, the balance should be shortly switched off. The weighing process must then be restarted from the beginning.

Fault:

Possible causes:

The weight display does not glow.

- The balance is not switched on
- The mains supply connection has been interrupted (mains cable not plugged in/faulty).
- Power supply interrupted.
- Rechargeable battery inserted incorrectly or empty
- No rechargeable battery inserted

The displayed weight is permanently changing

- Draught/air movement
- Table/floor vibrations
- The seating surface is in contact with foreign bodies or is not correctly positioned.
- Electromagnetic fields / static charging (choose different location/switch off interfering device if possible)

The weighing result is obviously incorrect

The display of the balance is not at zero
Adjustment is no longer correct

- Great fluctuations in temperature
- The balance is on an uneven surface
- Electromagnetic fields / static charging (choose different location/switch off interfering device if possible)

No data can be transferred to the WIFI interface

- The mains signal is not stable or too weak
- Wrong interface configuration

Should other error messages occur, switch balance off and then on again. If the error message remains inform manufacturer.

17 Verification

General:

According to EU directive 2014/31/EU balances must be officially verified if they are used as follows (legally controlled area):

- a) For commercial transactions if the price of goods is determined by weighing.
- b) For the production of medicines in pharmacies as well as for analyses in the medical and pharmaceutical laboratory.
- c) For official purposes
- d) For manufacturing final packages
- e) Determination of mass in the practice of medicine that is, weighing patients for reasons of medical supervision during medical surveillance, examination and treatment,

In cases of doubt, please contact your local trade in standard.

Verification notes:

An EU type approval exists for balances described in their technical data as verifiable. If the balance is used where obligation to verify exists as described above, it must be verified and re-verified at regular intervals.

Re-verification of a balance is carried out according to the respective national regulations. For verification validity period, see chap. 17.1.

The legal regulation of the country where the balance is used must be observed!

	<p>Verification of the balance is invalid without the seal.</p> <p>The seal marks attached on balances with type approval point out that the balance may only be opened and serviced by trained and authorized specialist staff. If the seal mark is destroyed, verification loses its validity. Please observe all national laws and legal regulations. In Germany a re-verification will be necessary.</p>
---	---

Balances with obligation to verify must be taken out of operation if:

- The **weighing result** of the balance is outside the **error limit**. Therefore, in regular intervals load balance with known test weight (ca. 1/3 of the max. load) and compare with displayed value.
- The **reverification deadline** has been exceeded.

17.1 Verification validity period (current status in D)

Personal scales (including chair and wheelchair scales) in hospitals	4 years
Personal balances, when not located in hospitals (for example, doctor's offices and nursing homes)	unlimited
Baby weighing scales and mechanical birth weight scales	4 years
Bed scales	2 years
Scales in dialysis stations	unlimited

Notes:

- Also rehab clinics and health authorities are treated as hospitals
- Not treated as hospitals (verification validity not limited) are dialysis stations, nursing homes and doctor's surgeries.

(Data source: "Bureau of Standards News, Weighing Instruments in Medicine")











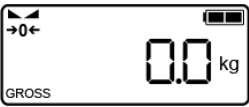
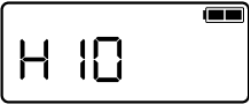
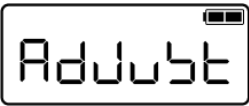



18 Adjustment

As the acceleration value due to gravity is not the same at every location on earth, each display unit with connected weighing plate must be coordinated - in compliance with the underlying physical weighing principle - to the existing acceleration due to gravity at its place of location (only if the weighing system has not already been adjusted to the location in the factory). This adjustment process must be carried out for the first commissioning, after each change of location as well as in case of fluctuating environment temperature. To receive accurate measuring values it is also recommended to adjust the display unit periodically in weighing operation.

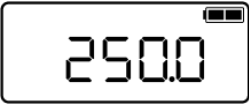
	<ul style="list-style-type: none">• Prepare the required adjustment weight. The adjustment weight to be applied depends on the capacity of a weighing scale, see chap. 1. Carry out adjustment as closely as possible to admissible maximum load of weighing scale. Info about test weights can be found on the Internet at: http://www.kern-sohn.com.• Observe stable environmental conditions. For warm-up time required for stabilisation see chap.1.
---	--

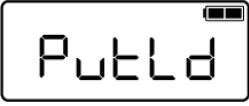
	<p>Access to service menu „x10“ is locked in verified balances. To disable the access lock, destroy the seal mark and actuate the adjustment switch. Position of the adjustment switch see chap. 18.1.</p> <p>Attention: After destruction of the seal the weighing system must be re-verified by an authorized agency and a new verification wire/seal mark fitted before it can be reused for applications subject to verification.</p>
--	--

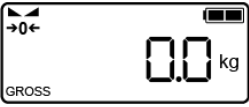
Procedure:

 	<p>⇒ In weighing mode Actuate adjustment switch. The service menu is called up. The first menu item "X10" appears.</p>
	<p>⇒ Press , the next menu item "AdJuSt" appears</p>
	<p>⇒ Acknowledge by , „cAL“ is displayed.</p>
	<p>⇒ Press  again , „cALEXt“ is displayed. (should this not be displayed, press   repeatedly until „cALEXt“ is displayed)</p>
	<p>⇒ Press , the required adjustment weight is shown</p> <p>⇒ Acknowledge by , „Zero“ is shortly displayed: Ensure that there are no objects on the weighing plate.</p>
	<p>⇒ „PutLd“ is displayed. During this display place the required adjustment weight on the weighing surface</p>
 	<p>⇒ Press , „rEMVLd“ is displayed. Remove the adjustment weight. The balance changes automatically into the weighing mode, the adjustment is concluded now.</p>

An adjusting error or incorrect adjustment weight will generate an error message („WronG“), repeat the adjustment process.

18.1 Adjustment switch and seal marks

Position adjustment switch and seal marks:

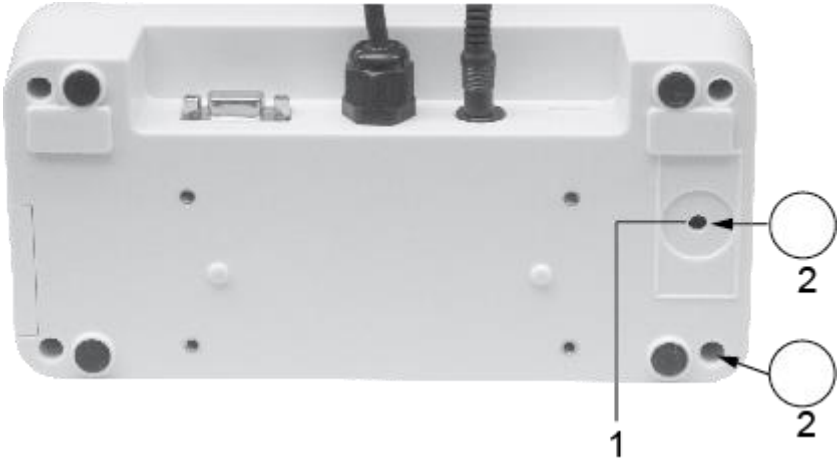

- 1. Adjustment switch
- 2. Self-destroying seal mark