



KERN & Sohn GmbH

Ziegelei 1
72336 Balingen-Frommern
Germany

+0049-[0]7433-9933-0
+0049-[0]7433-9933-149
info@kern-sohn.com

Installation Instructions

Analogue module

KERN KUP-08

Type TYKUP-08-A
Version 1.1
2023-06
GB



The current version of these instructions can also be found online under:
<https://www.kern-sohn.com/shop/de/DOWNLOADS/>
under the rubric Instruction manuals

TYKUP-08-A-IA-e-2311



Analogue module
Version 1.1 2023-06
Installation Instructions

Contents

1	Scope of delivery	3
2	General and safety information	3
3	Installation.....	4
3.1	Configuration of the module	4
3.2	Connect the module to the scale	6

1 Scope of delivery

- Analogue module

2 General and safety information

⚠ DANGER



The electrical shock caused by touching live components

An electrical shock results in serious injury or death.

- ⇒ Before opening the device, disconnect it from the power source.
- ⇒ Only perform installation work on devices that are disconnected from the power source.

NOTICE



Electrostatically endangered structural components

Electrostatic Discharge (ESD) can cause damage to electronic components. A damaged component may not always malfunction immediately but may take some time to do so.

Make sure to take precautions for ESD protection before removing hazardous components from their packaging and working in the electronic area:

- ⇒ Ground yourself before touching electronic components (ESD clothing, wristband, shoes, etc.).
- ⇒ Only work on electronic components at suitable ESD workplaces (EPA) with suitable ESD tools (antistatic mat, conductive screwdrivers, etc.).
- ⇒ When transporting electronic components outside the EPA, only use suitable ESD packaging.
- ⇒ Do not remove electronic components from their packaging when they are outside the EPA.

3 Installation

INFORMATION



- It is important to follow the instructions in this manual before starting work.
- The illustrations shown are examples and may differ from the actual product (e.g. positions of the components).

3.1 Configuration of the module

1. Remove the module from the packaging.
2. Remove the upper half of the module enclosure (clamp fastening).

Side view:

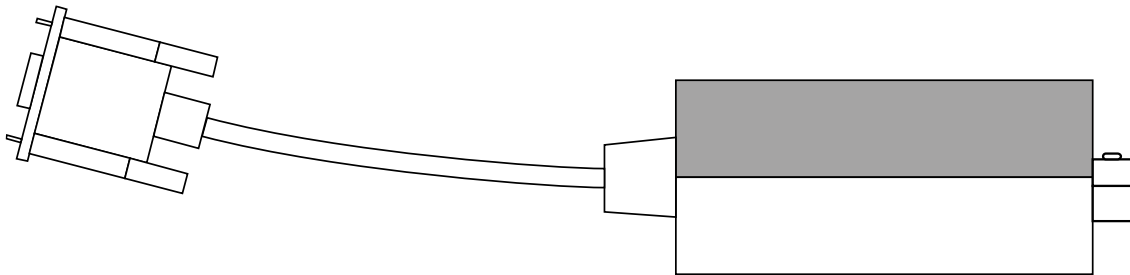

3. Remove the screws of the cable gland and take out the cable gland completely.

Aerial view

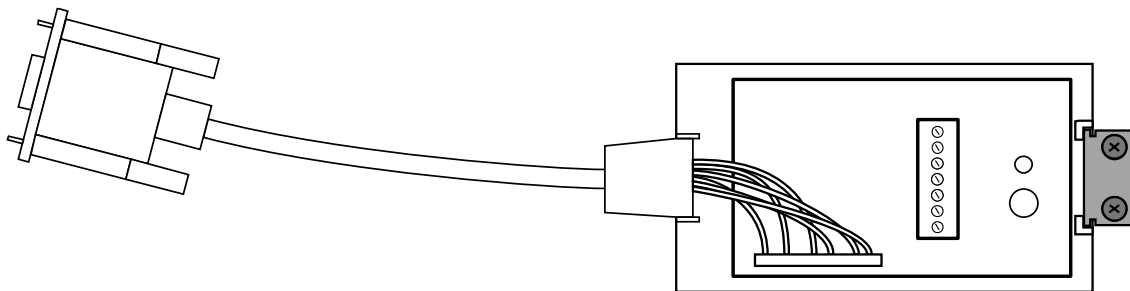

4.



NOTICE

- ⇒ Make sure that the supply voltage does not fall below or exceed 12 - 15 VDC.
- ⇒ Make sure that each pair of cable clamps used (A, B, C) is correctly connected to the ground.

Plug the line cores of the interface cable into the cable clamps of the module.

A: Supply voltage

B: Analogue-Output 0 – 10 VDC

C: Analogue Output 4 – 20 mA

Connections **B** and **C** can be used as parallel connections. You can set on the scale whether B or C is to be used.

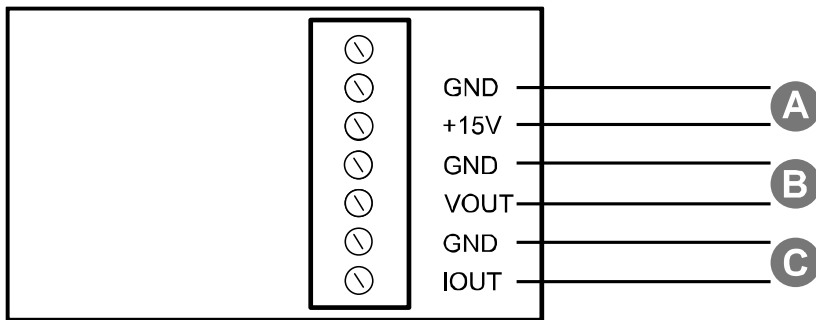

5. Carefully tighten the screws of the cable clamps so that the contact tips are fixed.

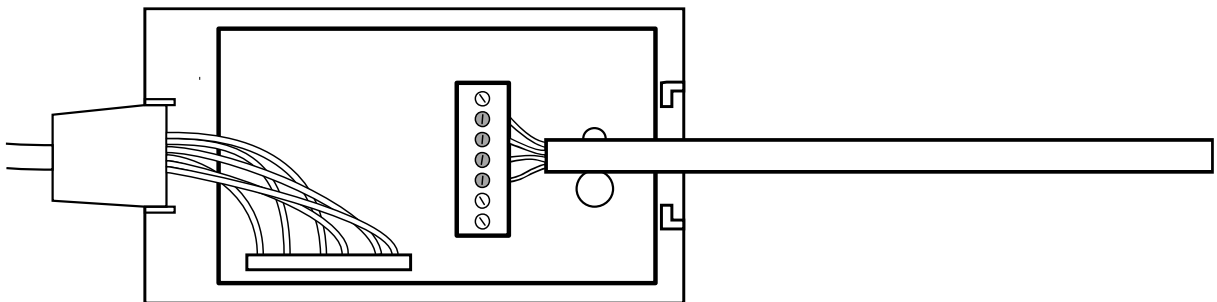

6. Insert the lower part of the cable gland into the guide of the module enclosure and place the cable into the cable gland.

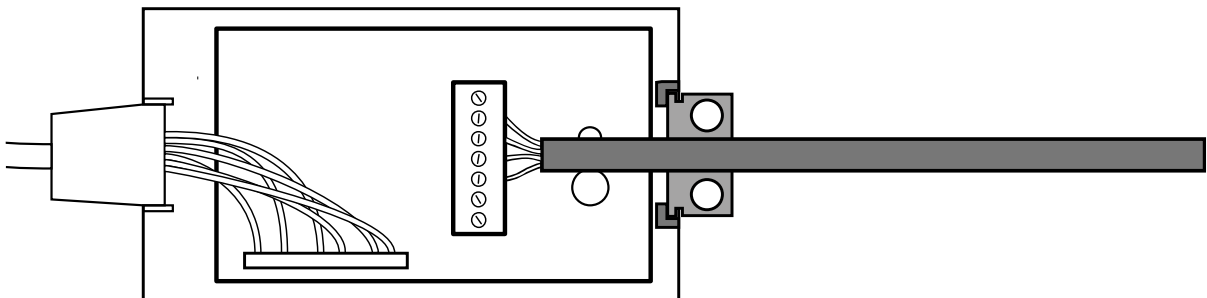

7. The upper half of the cable gland is screwed onto the lower half.

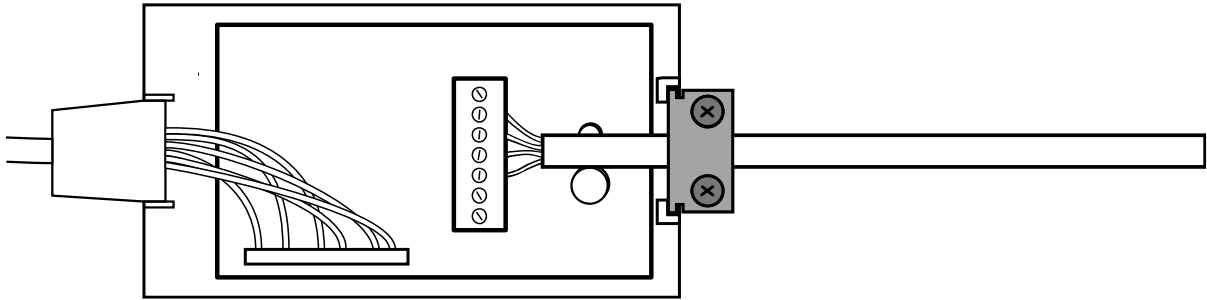

8. Clip the upper half of the module enclosure back on.

Side view:

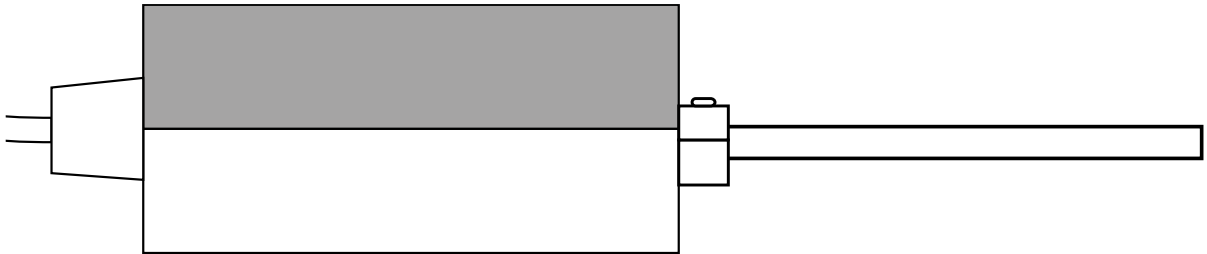

3.2 Connect the module to the scale

1. Turn off appliance
2. Plug the KUP adapter into the 15-pin sub-D connector of the scale.
3. Switch on the unit.
4. Make the communication settings for the analogue module in the menu of the scale. Information on this can be found in the instruction manual of your scale.