



Coating thickness gauge

JCT

JCT 100



PROFESSIONAL MEASURING

English version

Operating instructions Coating thickness gauge

Version 1.0
2024-03
en
JCT-BA-e-2410

de

Weitere Sprachversionen
finden Sie online unter

www.kern-sohn.com/manuals

fr

Vous trouverez d'autres
versions de langue online
sous

www.kern-sohn.com/manuals

bg

Други езикови версии ще
намерите в сайта

www.kern-sohn.com/manuals

el

Άλλες γλωσσικές αποδόσεις
θα βρείτε στην ιστοσελίδα

www.kern-sohn.com/manuals

hr

Druge jezične verzije su
dostupne na stranici :

www.kern-sohn.com/manuals

lv

Citas valodu versijas
atradīsiet vietnē

www.kern-sohn.com/manuals

pt

Encontram-se online mais
versões de línguas em

www.kern-sohn.com/manuals

sl

Druge jezikovne različice na
voljo na spletni strani

www.kern-sohn.com/manuals

en

Further language versions
you will find online under

www.kern-sohn.com/manuals

it

Trovate altre versioni di
lingue online in

www.kern-sohn.com/manuals

cs

Jiné jazykové verze najdete
na stránkách

www.kern-sohn.com/manuals

et

Muud keeleversioonid leiata
Te leheküljel

www.kern-sohn.com/manuals

hu

A további nyelvi változatok a
következő oldalon
találhatók:

www.kern-sohn.com/manuals

nl

Bijkomende taalversies vindt
u online op

www.kern-sohn.com/manuals

ro

Alte versiuni lingvistice veți
găsi pe site-ul

www.kern-sohn.com/manuals

sv

Övriga språkversioner finns
här

www.kern-sohn.com/manuals

es

Más versiones de idiomas
se encuentran online bajo

www.kern-sohn.com/manuals

pl

Inne wersje językowe znajdują
Państwo na stronie

www.kern-sohn.com/manuals

da

Flere sprogudgaver findes
på websiden

www.kern-sohn.com/manuals

fi

Muut kieliversiot löytyvät
osoitteesta

www.kern-sohn.com/manuals

lt

Kitas kalbines versijas rasite
svetainėje

www.kern-sohn.com/manuals

no

Andre språkversjoner finnes
det på

www.kern-sohn.com/manuals

sk

Iné jazykové verzie nájdete
na stránke

www.kern-sohn.com/manuals



SAUTER GmbH

Ziegelei 1
72336 Balingen-Frommern
Germany



+0049-[0]7433-9933-0



+0049-[0]7433-9933-149



info@kern-sohn.com



www.sauter.eu



SAUTER

SAUTER JCT

Coating thickness gauge

Operating instructions Coating thickness gauge

Version 1.0 2024-03 English version

Table of contents:

1	Technical data	2
2	Declaration of Conformity	4
3	Overview of the device	5
3.1	Scope of delivery	5
3.2	Components	5
4	Basic information (general)	7
4.1	General information on warning notices	7
4.2	Intended use	8
4.3	Improper use	8
4.4	Warranty	9
5	Basic warnings and safety instructions	10
5.1	Observe the notes in the operating instructions	10
5.2	Staff training	10
5.3	Security	10
6	Transport and storage	13
7	Unpacking and commissioning	14
7.1	Unpacking	14
7.2	Initial commissioning	14
8	Menu	15
8.1	Menu icons	15
8.2	Main interface	15
8.3	Single point	15
8.4	Several points	16
9	Basic operation	17
9.1	Switch device on/off	17
9.2	Measurement	17
9.3	Menu	18
9.4	Calculated values	21
9.5	Quick test mode	21
9.6	Troubleshooting	22
10	Calibration	23
10.1	Zero point calibration	23
10.2	Two-point calibration	23
11	Battery operation / power supply	25
12	Bluetooth interface	26
13	Maintenance, servicing and disposal	27
13.1	Cleaning	27
13.2	Maintenance and repair	27
13.3	Waste disposal	27
14	Battery law	28

1 Technical data

Function	Range	Resolution	Description
Range	0~2000µm 0~78.7 million		
Resolution	0~99.9µm	0.1µm	
	100~2000µm	1µm	
	0~4.99 million	0.01 million	
	5.0~78.7 million	0.1 million	
Accuracy	±(2%H+2) µm		
	±(2%H+0.08) mil		
Bluetooth app	System requirements		
Search time	5 min		If there is no connection for 5 minutes, the Bluetooth function is automatically switched off
Transmission distance	≥10m		
Probe measuring force	0.3~1.5N		Measuring force range of the probe
Display	Colour display		2" TFT colour screen
Automatically rotating screen	According to the built-in gravity sensor		4 directions: 0°, 90°, 180° and 270°
Conversion into units	µm/mil		Conversion metric/imperial unit
LED alarm	The LED lights up in the corresponding colour when the value exceeds the set range for the alarm.		
Audio alarm	A corresponding signal tone sounds when measurements, alarms and button presses occur.		The buzzer must be switched on.
Limit value setting	0~2000µm		
Measurement modes	One-off/continuous		
Statistical measurement	MAX/MIN/AVG		
Matrix identification modes	Automatic/manual		
Voice transmission	Voice broadcast for measured values		The voice transmission function must be switched on.

Torch	Easy to use in dark environments	
USB communication	Upper computer communication	Export of saved data via the upper computer
Storage of data	3300 data (55 groups * 60)	
Brightness of the backlight	5 levels	
Automatic switch-off	5 minutes	
Low battery indicator	Low battery indicator at 3.4V±0.2V	
Electricity	3.7V 1300mAh lithium battery	
Operating environment	0~40°C ≤80%RH	
Storage environment	-20~60°C ≤75%RH	

2 Declaration of Conformity

The current EC/EU Declaration of Conformity can be found online at
<https://www.kern-sohn.com/shop/de/DOWNLOADS/>

3 Overview of the device

3.1 Scope of delivery

- Coating thickness gauge
- Operating instructions
- Storage box
- Standard Layer thickness Sheet s
- Ferrous matrix
- Non-ferrous matrix
- Sensor protective cover
- Hand strap
- USB cable
- 3.7V 4.81Wh rechargeable lithium battery

3.2 Components



Description of the	Function
1	LED alarm light
2	LCD
3	Power/flashlight
4	Confirm/Menu
5	Repeat/delete
6	Down/Automobile mode
7	Upwards/histogram
8	Sensor
9	Hand strap Buckle

10	USB/charging interface
11	Torch
12	Loudspeaker





4 Basic information (general)

4.1 General information on warning notices

Warnings are used in these operating instructions to warn you of possible personal injury or damage to property in certain situations.

Signal word	Description of the
DANGER	Failure to observe the instructions will lead directly to serious injury, permanent impairment (e.g. loss of a limb) or death of the user or third parties
WARNING	Failure to observe the instructions may result in serious injury, permanent impairment (e.g. loss of a limb) or death of the user or third parties
CAUTION	Failure to observe the instructions may result in minor injuries or temporary damage to the user or third parties (e.g. minor cuts)
NOTE	Failure to observe the instructions may result in damage to property

Symbols in warning notices :

Symbol	Meaning
Warning signs	Warning signs warn you of dangers that may lead to personal injury. The symbol indicates the type of hazard.
	Indicates general hazards or a danger point
	Warning of electrical voltage
	Warning of flammable substances
	Warning of explosive substances

Symbol	Meaning
Command sign	Mandatory signs prescribe measures that you must take to avoid personal injury or damage to property. The symbol indicates the necessary actions or objects to prevent damage.
	Indicates a prescribed action

4.2 Intended use

The JCT 100 is an improved high-performance coating thickness gauge that can measure the coating thickness on both ferrous and non-ferrous metallic base materials. This device has features such as high precision, stable and reliable performance and non-destructive measurement, etc. It has functions such as automotive mode, voice transmission, Bluetooth APP and LED torch. It is a necessary device for automobile manufacturing, sales, appraisal, metal processing, painting, inspection and other industries. It is widely used in manufacturing, metal processing, aerospace, shipping, high-speed trains, scientific research, quality monitoring and other fields.

The product is based on the principles of electromagnetic induction and eddy current measurement.

The principle of electromagnetic induction measurement is to measure the coating thickness based on the magnitude of the magnetic flux flowing from the sensor through the non-ferrous magnetic layer into the ferromagnetic matrix. The symbol is Fe. It can measure non-conductive or conductive coatings on magnetically permeable metals such as iron and steel (e.g. galvanised sheet steel).

The principle of eddy current measurement is to measure the coating thickness based on the difference in eddy current formed by an alternating magnetic field on a non-magnetic metal matrix (e.g. aluminium). The symbol is NFe. It can measure non-conductive coatings on non-magnetic metal materials such as aluminium and copper. The matrix must be made of metal and the coating must not conduct electricity.

If you have any questions, please contact SAUTER or visit our website www.sauter.eu.

4.3 Improper use

The measuring device is not to be used for medical purposes.

Do not use or store the measuring device in environments with high temperatures, high humidity, flammable or explosive substances and strong magnetic fields. This device is not waterproof and cannot be used in environments with high humidity or water mist. Avoid the ingress of liquids, powders or solid foreign bodies such as water and dust into the measuring opening and the housing.

Unauthorised structural changes, additions or conversions to the device are prohibited. Unauthorised modifications may impair the accuracy of the device or even cause irreversible damage to the device.

4.4 Warranty

Warranty expires with

- Non-compliance with our specifications in the operating instructions
- Use outside the described applications
- Modifying or opening the device
- Mechanical damage and damage caused by media, liquids, natural wear and tear
- Improper set-up or electrical installation
- Improper assembly or electrical installation

5 Basic warnings and safety instructions

5.1 Observe the notes in the operating instructions



Read the operating instructions carefully before commissioning/using the appliance, even if you already have experience with SAUTER appliances. Always keep the instructions in the immediate vicinity of the appliance.

5.2 Staff training

The appliance may only be used by persons who have read and understood the operating instructions, in particular the chapter on safety.

5.3 Security

⚠ WARNING	
	<p>Read all safety information and instructions. Failure to observe the safety information and instructions may result in electric shock, fire and/or serious injury.</p> <p>Keep all safety information and instructions for future reference.</p> <ul style="list-style-type: none">● Make sure that there are never people or objects under the load, as these could be injured or damaged!● The design of the measuring device must not be modified. This can lead to incorrect measurement results, safety-related defects and the destruction of the measuring device● Do not operate the appliance in potentially explosive rooms or areas and do not install it there.● Do not operate the device in an aggressive atmosphere.● Do not immerse the appliance in water. Do not allow any liquids to penetrate the inside of the appliance.● The device may only be used in a dry environment and under no circumstances in rain or at a relative humidity above the operating conditions.● Protect the device from permanent direct sunlight.● Do not expose the appliance to strong vibrations.● Do not remove any safety signs, stickers or labels from the appliance. Keep all safety signs, stickers and labels in a legible condition● Do not open the device

⚠ WARNING



Risk of injury from electric shock!

There is a risk of injury from electric shock when cleaning the electrical system with wet cloths.

- Switch off the power supply using the main switch.
- Unplug the mains plug.
- Do not use wet cleaning cloths.
- Always use only dry or moistened cloths.

⚠ WARNING



Choking hazard!

Do not leave the packaging material lying around carelessly. It could become a dangerous toy for children.

- The appliance is not a toy and does not belong in the hands of children.
- This appliance can be dangerous if it is used improperly or not as intended by untrained persons! Observe the personnel qualifications!

⚠ WARNING



Improper use of rechargeable or non-rechargeable batteries can cause them to catch fire, explode, emit toxic vapours or release corrosive liquids. The following therefore applies to rechargeable and non-rechargeable batteries:

- Protect from fire and heat.
- Never expose to high pressure or microwaves.
- Do not bring into contact with liquids or chemicals.
- Never bring the electrical contacts of rechargeable batteries and batteries into contact with metal objects or short-circuit them.
- Never modify rechargeable batteries, batteries and chargers.
- Batteries must never be charged.
- Never use or charge a defective, damaged or deformed battery.
- Do not use any other power supply units that do not comply with the technical specifications. Doing so may shorten the battery life or even cause an electric shock, which may damage the appliance or cause a fire.
- If the appliance is not used for an extended period of time, the external power supply should be disconnected to prevent the appliance from burning and causing a fire.
- If you do not use the device for a long time, you should charge it every fortnight, otherwise the internal battery is easily damaged, making it impossible to use the device again

CAUTION

- Keep a sufficient distance from heat sources.
- Do not shine the torch into the eyes.
- Do not use the device in environments with high humidity or water mist.

 **NOTE**

- To prevent damage to the device, do not expose it to extreme temperatures, extreme humidity or moisture.
- Do not use harsh cleaning agents, abrasive cleaners or solvents to clean the appliance.

6 Transport and storage

Hint

If you store or transport the device improperly, the device may be damaged. The standard thickness plates are high-precision accessories that are related to the accuracy of the gauge and must be properly preserved to avoid scratching, corrosion, bending and deformation of the surface. The metal moulds must also be properly preserved to prevent scratches, rust, oxidation and surface deformation. Observe the information on transporting and storing the appliance.

Transport

When transporting the appliance, use the practical storage box included in the scope of delivery to protect the appliance from external influences.

Storage

Observe the following storage conditions when the appliance is not in use:

- dry and protected from frost and heat
- Protected from dust ingress in the storage box
- the storage temperature corresponds to the technical data
- Please use the sensor protective cover and keep the sensor clean and in good condition so that dust, oil and other factors do not affect the measurement accuracy.

Packaging/return transport

Returns are only possible within the limits of the general terms and conditions. Keep all parts of the original packaging for any necessary return transport.

- Only the original packaging is to be used for return transport.
- Disconnect all connected cables and loose/movable parts before despatch.
- Refit any transport locks provided.
- Secure all parts against slipping and damage.

7 Unpacking and commissioning

7.1 Unpacking



In the event of a return, please observe the instructions in the chapter "Packaging/return transport"













On receipt of the appliance, you should first check that no damage has occurred in transit, that the outer packaging, the housing, other parts or even the appliance itself have not been damaged. If any damage is evident, please notify SAUTER GmbH immediately.

7.2 Initial commissioning

When switching on the measuring device, a self-test is required for initialisation. When you switch on the measuring device, please do not hold the sensor near metal objects, otherwise the measuring device will be unusable.

8 Menu

8.1 Menu icons

	Automatic screen rotation	$\mu\text{m}/\text{mil}$	Units	Mode	Probe modes
Group	Storage location		Measuring modes		Upper limit
	Lower limit		LED alarm		Voice transmission
	Calibration modes		Languages		Buzzer
	Brightness of the backlight		Bluetooth communication		Restore factory settings

Note: If the colour of the icon is white, users can adjust the settings elements. If the icon is brown, users can only search through the settings elements.

8.2 Main interface

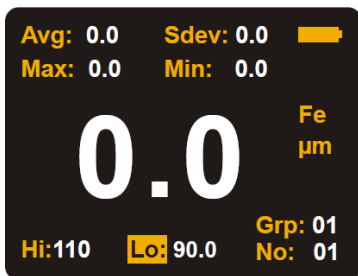

8.3 Single point

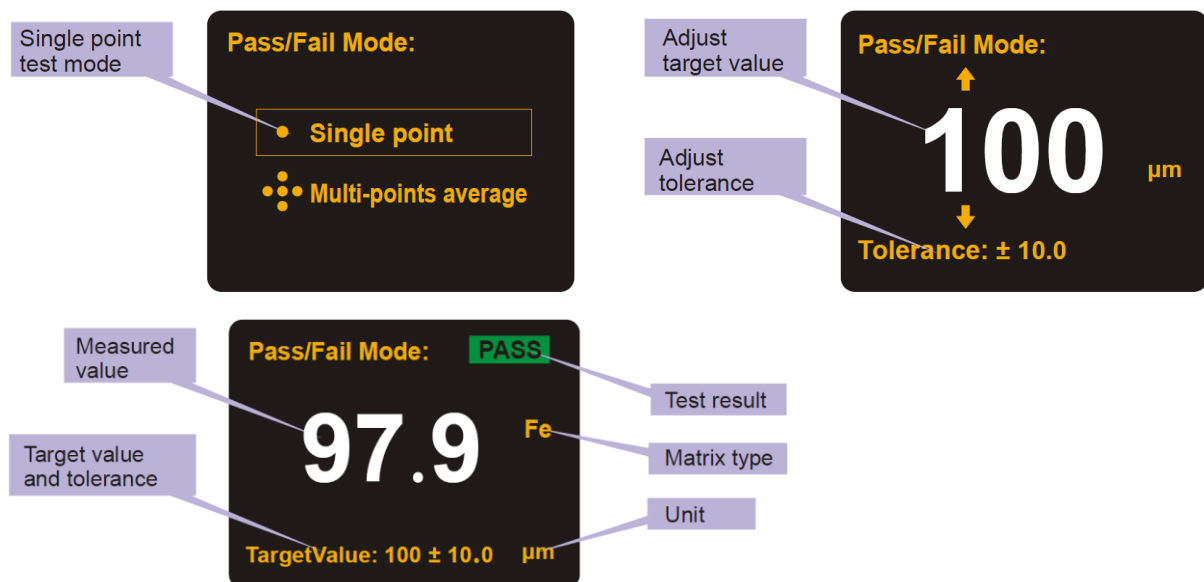

8.4 Several points

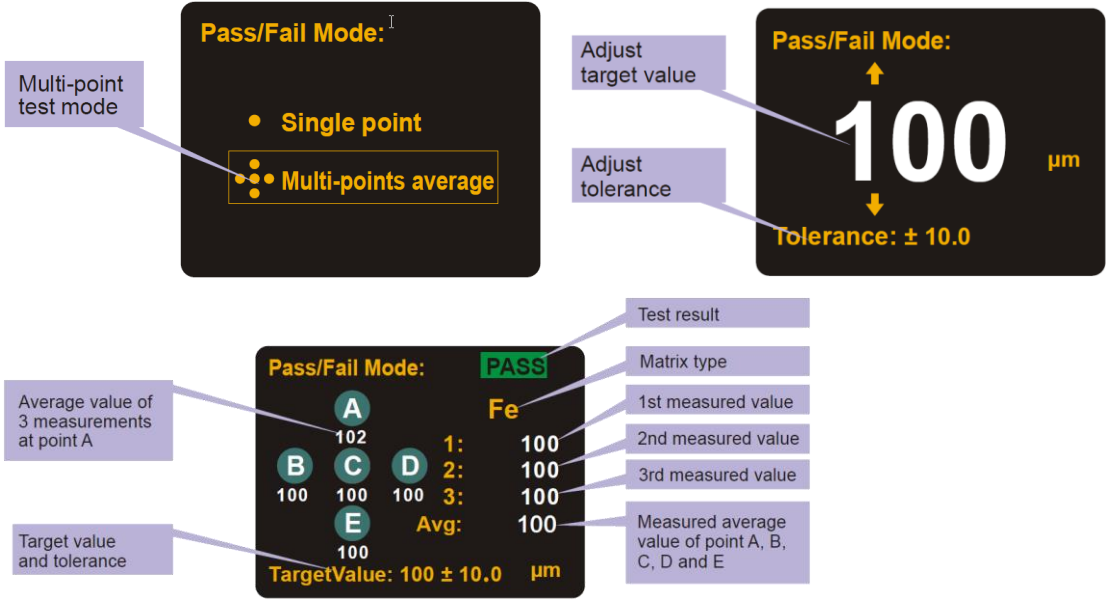

9 Basic operation

9.1 Switch device on/off

Press and hold  to switch the measuring device on/off.

9.2 Measurement

Note: Keep the probe away from metal objects before switching on the device.

- Press and hold  to switch on the device. After initialisation, the main interface is called up
- If the product has not been used for a long time or the operating environment has changed, a two-point calibration is required before use
- First press the probe vertically onto the object to be measured. The value shown on the LCD display at this point is the estimated value for the coating thickness
- Refer to this estimated value and select a standard coating thickness plate from the accessories that comes closest to this value to prepare the two-point calibration
- If possible, a matrix should be selected as the calibration matrix whose thickness or material is close to the measurement object and which has no coating. If the above-mentioned matrix cannot be found, the standard matrix from the accessories can be selected as the calibration matrix (the measurement results may be distorted due to differences in material and thickness)
- Information on two-point calibration can be found in the "Calibration" chapter.
- Once the two-point calibration has been completed and repeatedly checked, the coating thickness of the object can be measured.
- When measuring, select 3 to 5 measuring points evenly on the surface of the measurement object, measure 5 times at each point and take the average value of the 5 measurements as the display value of the point.
- After the display values of the 3 to 5 measuring points have been measured, the average of the values should be taken as the reference value for the object layer thickness.

Remark:







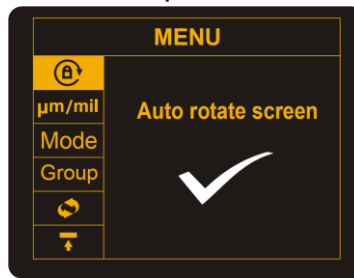

- Hold the measuring device perpendicular to the object to be measured and press the measuring device sensor lightly against the object surface to measure. It is necessary to keep the sensor in close contact with the surface of the object.
- If the measured display value is greater than 2000 μm , OL is displayed on the screen to indicate that the range has been exceeded.
- If the measured display value is greater than 2200 μm , the measuring device does not respond.

9.3 Menu







Briefly press  on the main interface to open the menu:









9.3.1 Automatic screen rotation

In the menu, press  or  to select the icon for the automatic rotation of the screen  and then briefly press  to access the settings interface. Press  or  to switch the auto-rotate function on or off and briefly press  to confirm or  to exit. Note: The meter has a built-in gravity sensor that allows the user to read the screen content from different angles (0°, 90°, 180° and 270°). If the automatic rotation function is switched off, the symbol  is displayed in the top right-hand corner of the screen.

9.3.2 Length Unit







In the menu, press  or  to select the symbol for the length unit $\mu\text{m}/\text{mil}$ and then briefly press  to call up the settings interface. Press  or  to select μm or mil and briefly press  to confirm or exit.

9.3.3 Probe mode

In the menu, press  or  to select the probe mode icon, and then press  briefly to enter the setting interface. Press  or  to select Auto/NFe/Fe mode and short press  to confirm or exit.









Automatic mode: In this mode, the matrix type of the measurement object (Fe or NFe) is recognised automatically. The sensor switches to a corresponding operating mode depending on the matrix type. Fe mode: The sensor switches to the electromagnetic induction operating mode. NFe mode: The sensor switches to eddy current operating mode.

9.3.4 Storage location of the data

In the menu, press  or  to select the Group data storage icon and then briefly press  to enter the settings interface. Press  or  to select the group number and briefly press  to confirm or exit.









Note: There are 55 groups and 60 data can be saved for each group.

9.3.5 Continuous measurement

In the menu, press  or  to select the continuous measurement icon  and then briefly press  to enter the settings interface. Press  or  to switch the continuous measurement mode on or off and briefly press  to confirm or  to exit.









Note: If this mode is switched on, the device will continue to measure until it is switched off.

9.3.6 Upper limit

In the menu, press  or  to select the upper limit icon  and then short press  to enter the setting interface. Short press  or  to add/subtract 1 to the single digit of the upper limit, and long press to add/subtract 1 to the tens digit. Briefly press  to confirm or  to exit.

Note: If the measured value is above the upper limit value and the LED alarm is switched on, the LED light flashes yellow.









9.3.7 Lower limit

In the menu, press  or  to select the symbol for the lower limit value  and then briefly press  to access the settings interface. Short press  or  to add/subtract 1 to the single digit of the lower limit, and long press to add/subtract 1 to the tens digit. Briefly press  to confirm or  to exit.









Note: If the measured value is below the lower limit value and the LED alarm is switched on, the LED light flashes red.

If the measured value is between the upper and lower limit values and the LED alarm is switched on, the LED light flashes green.









9.3.8 LED alarm

In the menu, press  or  to select the icon for the LED alarm  and then briefly press  to access the settings interface. Press  or  to switch the LED alarm on or off and briefly press  to confirm or  to exit.

9.3.9 Voice transmission









In the menu, press  or  to select the voice transmission icon  and then briefly press  to access the settings interface. Press  or  to switch the voice transmission function on or off and briefly press  to confirm or  to exit.

9.3.10 Calibration mode









In the menu, press  or  to select the calibration mode icon  and then briefly press  to enter the settings interface. Press  or  to select a calibration mode (one-point or two-point) and briefly press  to confirm or  to exit.

Note: The two-point calibration mode is used more frequently than the single-point mode. commonly used than the single-point mode.

9.3.11 Language









In the menu, press  or  to select the language selection icon  and then briefly press  to access the settings interface. Press  or  to select English or Chinese and briefly press  or  to confirm and exit the menu.

9.3.12 Buzzer









In the menu, press  or  to select the buzzer icon  and then briefly press  to access the settings interface. Press  or  to switch the buzzer on or off and briefly press  to confirm or  to exit.

If this function is switched on and the measuring device receives the measured value in normal measuring mode, the buzzer sounds.

9.3.13 Backlight brightness







In the menu, press  or  to select the  icon for the backlight brightness and then briefly press  to access the settings interface. Press  or  to set the brightness and briefly press  to confirm or  to exit.

9.3.14 Bluetooth

In the menu, press  or  to select the Bluetooth icon  and then briefly press  to access the settings interface. Press  or  to switch Bluetooth on or off and briefly press  to confirm or  to exit.

Note: If there is no connection for 5 minutes, the Bluetooth function is automatically switched off.

9.3.15 Restore factory settings





In the menu, press  or  to select the  icon for restoring the factory settings and then briefly press  to enter the settings interface. Press  or  to switch the factory reset function on or off and briefly press  to confirm or exit.

9.4 Calculated values

Four values are calculated automatically and displayed at the top of the screen: Avg, Min, Max, Sdev. In the main interface, press  for 2 seconds to delete the currently calculated values.







Note: All saved data will be deleted when the user performs the above procedure.

9.5 Quick test mode









On the main interface, long press  to enter the quick test mode. Press  or  to select the single-point test or multi-point test and briefly press  to confirm or  to exit.

Note: The rapid test mode is mainly used for measuring the coating thickness of automotive and other industrial products.

9.5.1 Single point

- Press  or  to set the target value for the thickness and then press  to confirm.
- Press  or  to set the tolerance and press briefly to enter single-point quick test mode;
- Measure the layer thickness of the measurement object;
- The measured value and the test result ("PASS" or "FAIL") are immediately displayed on the screen;
- Briefly press  to return or press and hold  to exit single-point quick test mode.

9.5.2 Several points

- Press  or  to set the target value for the thickness and then press  to confirm;
- Press  or  to set the tolerance and briefly press  to enter multi-point quick test mode;
- Measure the coating thickness of the object to be measured. Take 3 measurements in the vicinity of the same position and
- the measuring device calculates the average of the 3 times as the value of point A;
- Change a position and take 3 measurements in the vicinity of the new position. The measuring device calculates the average of
- 3 times the value of point B;
- The measurement methods for points C, D and E are the same as above;
- Once the measurement is complete, the average value of these 5 points is immediately displayed on the screen
- and the test result ("PASS" or "FAIL");
- Briefly press  to return or press and hold  to exit multipoint quick test mode.



9.6 Troubleshooting

If errors occur, select "Restore factory settings" in the menu.

10 Calibration

On the main interface, press and hold  to enter the selected calibration mode.

Note: The selected calibration mode depends on the setting in chapter 9.3.10 .



Calibration modes	Icons	Description
Zero-point calibration		Place the sensor on an uncoated metal matrix
Two-point calibration		The standard coating thickness sheet and uncoated matrix are stacked together for calibration, and more accurate measurement results can be got.

10.1 Zero point calibration

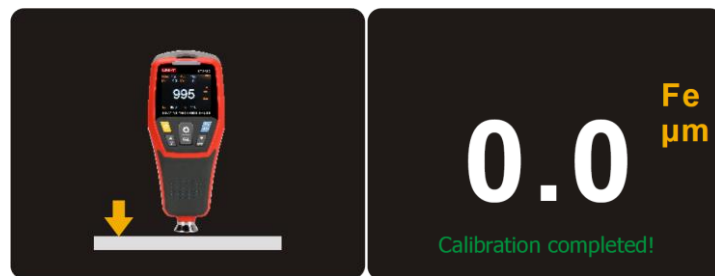
- Place the gauge vertically on the uncoated mould as shown in the following illustration
- Pick up the meter after 2 seconds. The screen will display the value 0.0 as shown in Figure 2 and the meter will automatically return to the main interface;
- The zero point calibration is complete.



10.2 Two-point calibration

- Stack the standard layer thickness (e.g. 500 μm) and the uncoated matrix together for calibration, as shown in Figure 1.
- Lift the meter after 2 seconds and the reading will be displayed on the screen as shown in Figure 2
- Press  or  to adjust the measured value so that it matches the thickness value of the standard layer thickness sheet, as shown in Figure 3;
- Press  to confirm or press to cancel the calibration;
- Place the gauge vertically on the uncoated mould, as shown in Figure 4;
- Pick up the meter after 2 seconds. The value 0.0 is displayed on the screen as shown in Figure 5 and the meter automatically returns to the main interface;
- The two-point calibration is complete.



1



2

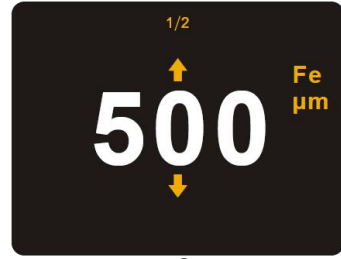

3



4

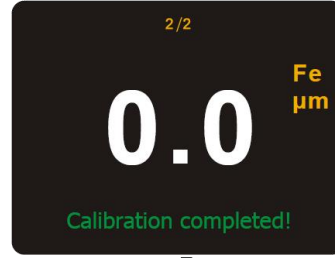

5

11 Battery operation / power supply

⚠ WARNING



Risk of fire and explosion due to incorrect charging or defective battery



Fire or explosion can lead to serious injuries

- ⇒ Please be sure to observe the notes on rechargeable batteries and batteries in the Safety chapter.
- ⇒ Observe the national and international transport regulations for devices with a permanently installed lithium-ion battery.
- ⇒ Do not replace defective batteries yourself! Contact SAUTER or a specialist dealer directly.

This device is equipped with a built-in rechargeable lithium-ion battery. Please use the original battery and do not replace any other batteries to avoid damage to the device or other failures.

- Nominal voltage 3.7 V
- Capacity 1300 mAh

The battery should be fully charged before first use. Use the original USB cable supplied for this purpose.

If the low battery symbol " " appears on the LCD display, charge the product in good time

12 Bluetooth interface

The device has a Bluetooth interface and an app for communication and use. The use of the Bluetooth function is described in chapter 9.3.14 is explained.

When using the Bluetooth communication function, the distance between the host and the mobile device should be less than 10 metres and there should be no obstacles or shielding metal objects in between.

13 Maintenance, servicing and disposal



Disconnect the appliance from the power supply before carrying out any maintenance, cleaning or repair work.

13.1 Cleaning

Clean the device with a damp, soft, lint-free cloth. Ensure that no moisture penetrates the housing. Do not use sprays, solvents, alcohol-based cleaners or abrasive cleaners, but only clear water to moisten the cloth to prevent damage to the measuring device

13.2 Maintenance and repair

Do not make any changes to the appliance and do not install any spare parts. Contact the manufacturer for repair or device inspection.

13.3 Waste disposal



Old appliances and accessories should not be disposed of with household waste.

The operator must dispose of the packaging and appliance in accordance with the applicable national or regional legislation at the place of use.

The device consists of various components and materials, such as

- Electronic components (circuit boards, electrical cables)
- Plastic (housing)
- Metal

Improper disposal of the appliance can have harmful effects on people and the environment.

Proper and environmentally friendly disposal can prevent harmful effects and recover raw materials.

Disposal of rechargeable batteries and batteries:

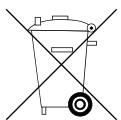

Rechargeable batteries and batteries do not belong in household waste.

The disposal of rechargeable batteries and batteries must be carried out by the operator in accordance with the applicable national or regional law of the place of use.

14 Battery law

Note in accordance with the Battery Act - BattG:

INFORMATION



- The following information is valid for Germany.

In connection with the sale of batteries and rechargeable batteries, we are obliged as a dealer under the Battery Act to inform end users of the following:

- End users are legally obliged to return used batteries and rechargeable batteries.
- After use, batteries and rechargeable batteries can be returned free of charge to municipal collection centres or retailers. The batteries/rechargeable batteries must have reached the end of their normal service life, otherwise precautions must be taken against short circuits.
- The return option is limited to batteries and rechargeable batteries of the type that we carry or have carried in our range and to the quantity that end users usually dispose of.
- A crossed-out wheelie bin means that you must not dispose of batteries or rechargeable batteries in household waste. Old batteries or rechargeable batteries may contain harmful substances that can damage people and the environment if not disposed of correctly.

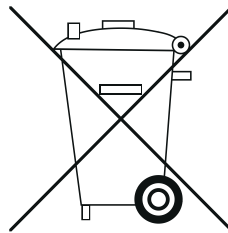

- Batteries containing harmful substances are labelled with a symbol consisting of a crossed-out dustbin and the chemical symbol (Cd = cadmium, Hg = mercury, or Pb = lead) of the heavy metal that is decisive for the classification as containing harmful substances.

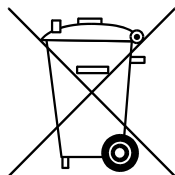

Cd

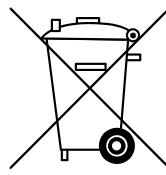

Hg

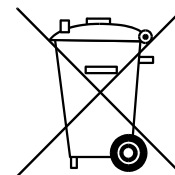

Pb