



Digital force gauge

FK



PROFESSIONAL MEASURING

English Version

Operating instructions digital force gauge

Version 3.0
2024-02
en
FK-BA-e-2430

de

Weitere Sprachversionen
finden Sie online unter

www.kern-sohn.com/manuals

fr

Vous trouverez d'autres
versions de langue online
sous

www.kern-sohn.com/manuals

bg

Други езикови версии ще
намерите в сайта

www.kern-sohn.com/manuals

el

Άλλες γλωσσικές αποδόσεις
θα βρείτε στην ιστοσελίδα

www.kern-sohn.com/manuals

hr

Druge jezične verzije su
dostupne na stranici :

www.kern-sohn.com/manuals

lv

Citas valodu versijas
atradīsiet vietnē

www.kern-sohn.com/manuals

pt

Encontram-se online mais
versões de línguas em

www.kern-sohn.com/manuals

sl

Druge jezikovne različice na
voljo na spletni strani

www.kern-sohn.com/manuals

en

Further language versions
you will find online under

www.kern-sohn.com/manuals

it

Trovate altre versioni di
lingue online in

www.kern-sohn.com/manuals

cs

Jiné jazykové verze najdete
na stránkách

www.kern-sohn.com/manuals

et

Muud keeleversioonid leiata
Te leheküljel

www.kern-sohn.com/manuals

hu

A további nyelvi változatok a
következő oldalon
találhatók:

www.kern-sohn.com/manuals

nl

Bijkomende taalversies vindt
u online op

www.kern-sohn.com/manuals

ro

Alte versiuni lingvistice veți
găsi pe site-ul

www.kern-sohn.com/manuals

sv

Övriga språkversioner finns
här

www.kern-sohn.com/manuals

es

Más versiones de idiomas
se encuentran online bajo

www.kern-sohn.com/manuals

pl

Inne wersje językowe znajdują
Państwo na stronie

www.kern-sohn.com/manuals

da

Flere sprogudgaver findes
på websiden

www.kern-sohn.com/manuals

fi

Muut kieliversiot löytyvät
osoitteesta

www.kern-sohn.com/manuals

lt

Kitas kalbines versijas rasite
svetainėje

www.kern-sohn.com/manuals

no

Andre språkversjoner finnes
det på

www.kern-sohn.com/manuals

sk

Iné jazykové verzie nájdete
na stránke

www.kern-sohn.com/manuals



SAUTER GmbH

Ziegelei 1
72336 Balingen-Frommern
Germany



+0049-[0]7433-9933-0



+0049-[0]7433-9933-149



info@kern-sohn.com



www.sauter.eu



SAUTER

SAUTER FK

Digital force gauge

Operating instructions digital force gauge

Version 3.0 2024-02 English Version

Table of contents:

1	Technical data	2
2	Declaration of conformity	3
3	Overview of the device	4
3.1	Scope of delivery	4
3.2	Dimensions	5
4	Basic information (general)	6
4.1	General information on warnings	6
4.2	Intended use	7
4.3	Improper use	7
4.4	Warranty	8
5	Basic warnings and safety instructions	9
5.1	Observe the notes in the operating instructions	9
5.2	Staff training	9
5.3	Security.....	9
6	Transportation and storage	12
6.1	Note	12
6.2	Transportation	12
6.3	Storage	12
6.4	Packaging/return transportation	12
7	Unpacking and commissioning	13
7.1	Unpacking.....	13
7.2	Initial commissioning	13
8	Menu	14
8.1	Display indication.....	14
8.2	Control buttons	14
8.3	Invert the display by 180°	14
9	Adjustment	15
10	Battery operation / power supply	17
11	Maintenance, servicing and disposal	18
11.1	Cleaning	18
11.2	Maintenance and repair.....	18
11.3	Waste disposal	18
12	Battery law	19

1 Technical data

Sauter model	FK 10	FK 25	FK 50	FK 100	FK 250	FK 500	FK 1k
Capacity	10N	25N	50N	100N	250N	500N	1000N
Working temperature	10°C to 30°C						
Relative humidity	15% to 80% humidity						
Weight	Approx. 720g						
Dimensions Display unit (LxWxH)	195x82x35mm						
Thread	M8						
Battery	6x 1.5 V AA batteries (alkaline (manganese))						
Accessories	Standard attachments and extension bar						



2 Declaration of conformity

The current EC/EU Declaration of Conformity can be found online at:

<https://www.kern-sohn.com/shop/de/DOWNLOADS/>

3 Overview of the device

3.1 Scope of delivery

- SAUTER FK
- 6 1.5V AA batteries
- Operating instructions
- Supplied in sturdy cardboard outer packaging
- 5 M3x8 screws for mounting on SAUTER test stands
- Standard attachments as standard, as illustrated
- Extension bar: 90mm



3.2 Dimensions

Dimensions in mm

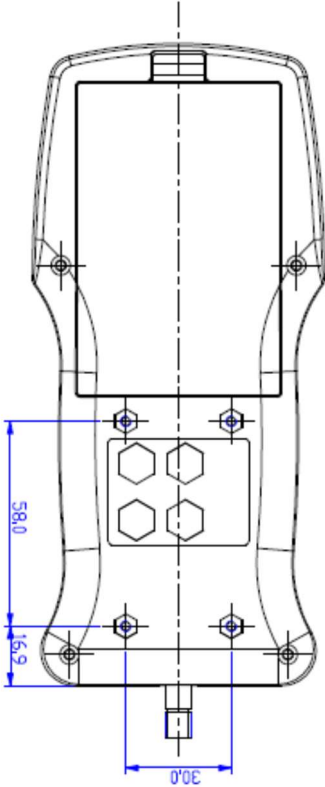
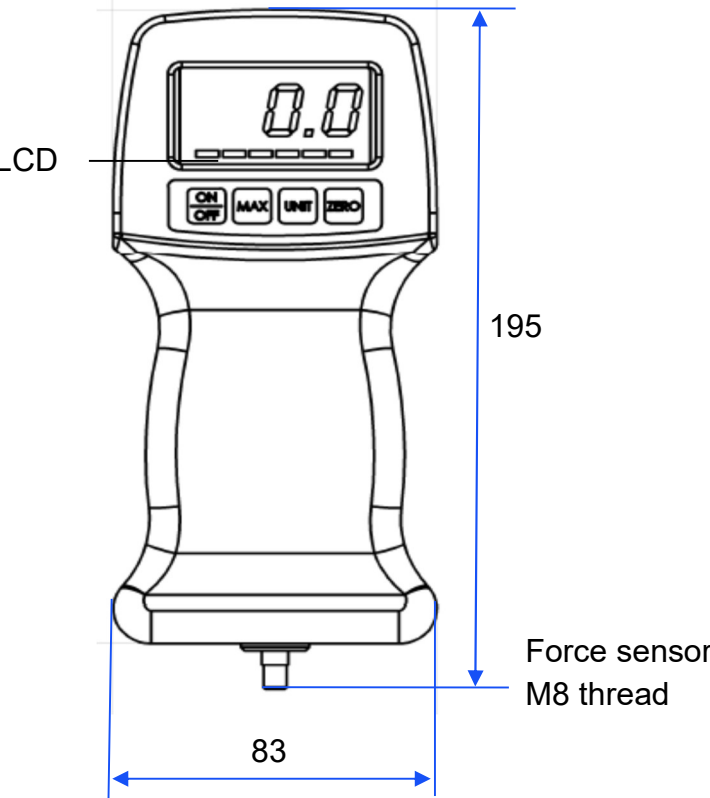







4 Basic information (general)

4.1 General information on warnings

Warnings are used in these operating instructions to warn you of possible personal injury or damage to property in certain situations.

Signal word	Description
DANGER	Failure to observe the instructions will lead directly to serious injury, permanent impairment (e.g. loss of a limb) or death of the user or third parties
WARNING	Failure to observe the instructions may result in serious injury, permanent impairment (e.g. loss of a limb) or death of the user or third parties
CAUTION	Failure to observe the instructions may result in minor injuries or temporary damage to the user or third parties (e.g. minor cuts)
NOTE	Failure to observe the instructions may result in damage to property

Symbols in warning notices:

Icon	Meaning
Warning signs	Warning signs warn you of dangers that may lead to personal injury. The symbol indicates the type of hazard.
	Indicates general hazards or a danger point
	Warning of electrical voltage
	Warning of flammable substances
	Warning of explosive substances
	Warning of falling loads
	Warning of suspended load

Icon	Meaning
Commandment sign	Mandatory signs prescribe measures that you must take to avoid personal injury or damage to property. The symbol indicates the necessary actions or objects to prevent damage.
	Indicates a prescribed action

4.2 Intended use

Only use the device to measure tensile and compressive forces within the measuring ranges specified in the technical data. Other areas of use/applications must be approved in writing by SAUTER. To use the device as intended, only use accessories or spare parts tested by SAUTER. SAUTER offers optional software and accessories to make the measuring device more versatile in use. Please ask SAUTER or the SAUTER supplier for details, or visit our website www.sauter.eu

In particular, it must be avoided that forces act on the purchased measuring device that exceed the maximum device load (Max) or do not act axially on the device via the load cell; or if high impulse forces act on the measuring device. Avoid twisting the load cell, as otherwise it could be damaged and the measuring accuracy will be reduced in any case.

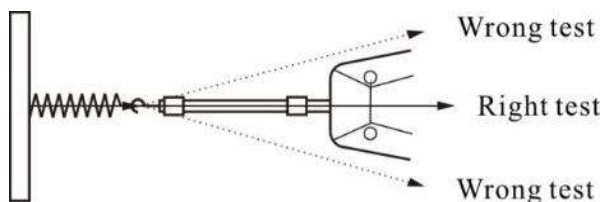

4.3 Improper use

The measuring device is unsuitable for weighing people, do not use as an infant measuring device! Do not use the measuring device for medical weighing.

If small quantities of the material to be measured are removed or added, incorrect measurement results may be displayed due to the "stability compensation" in the measuring device! (Example: Liquids flowing slowly out of a container suspended from the measuring cell).

Do not apply a continuous load to the measuring device with external measuring cell.

4.4 Warranty

Warranty expires with

- Non-compliance with our specifications in the operating instructions
- Use outside the described applications
- Modifying or opening the device
- Mechanical damage and damage caused by media, liquids, natural wear and tear
- Improper set-up or electrical installation
- Improper assembly or electrical installation

5 Basic warnings and safety instructions

5.1 Observe the notes in the operating instructions



Read the operating instructions carefully before commissioning/using the appliance, even if you already have experience with SAUTER appliances. Always keep the instructions in the immediate vicinity of the appliance.

5.2 Staff training

The appliance may only be used by persons who have read and understood the operating instructions, in particular the chapter on safety.

5.3 Security

Incorrectly performed force measurements can lead to serious injury to persons and damage to objects and must therefore only be carried out by trained and experienced personnel.

In particular, it must be avoided that forces act on the purchased measuring device that exceed the maximum load (Max) of the device or that do not act axially on the device via the external load cell; or if high impulse forces act on the measuring device. Please prevent the measuring device from being overloaded beyond the specified maximum load (Max), minus any existing tare load. This can damage the measuring device (risk of breakage!).

⚠ WARNING	
	<p>Read all safety information and instructions. Failure to observe the safety information and instructions may result in electric shock, fire and/or serious injury.</p> <p>Keep all safety information and instructions for future reference.</p> <ul style="list-style-type: none">● Make sure that there are never people or objects under the load, as they could be injured or damaged!● The design of the measuring device must not be modified. This can lead to incorrect measurement results, safety-related defects and the destruction of the measuring device● Do not operate the appliance in potentially explosive rooms or areas and do not install it there.● Do not operate the device in an aggressive atmosphere.● Do not immerse the appliance in water. Do not allow any liquids to penetrate the inside of the device.● The device may only be used in a dry environment and under no circumstances in rain or at a relative humidity above the operating conditions.● Protect the device from permanent direct sunlight.● Do not expose the appliance to strong vibrations.● Do not remove any safety signs, stickers or labels from the appliance. Keep all safety signs, stickers and labels in a legible condition● Do not open the device

⚠ WARNING



Risk of injury from electric shock!

There is a risk of injury from electric shock when cleaning the electrical system with wet cloths.

- Switch off the power supply using the main switch.
- Unplug the mains plug.
- Do not use wet cleaning cloths.
- Only ever use dry or damp cloths.

⚠ WARNING



Choking hazard!

Do not leave the packaging material lying around carelessly. It could become a dangerous toy for children.

- The appliance is not a toy and does not belong in the hands of children.
- This appliance can be dangerous if it is used improperly or not as intended by untrained persons! Observe the personnel qualifications!

⚠ WARNING



Improper use of rechargeable or non-rechargeable batteries can cause them to catch fire, explode, emit toxic fumes or release corrosive liquids. The following therefore applies to rechargeable and non-rechargeable batteries:

- Protect from fire and heat.
- Never expose to high pressure or microwaves.
- Do not bring into contact with liquids or chemicals.
- Never bring the electrical contacts of rechargeable batteries and batteries into contact with metal objects or short-circuit them.
- Never modify rechargeable batteries, batteries and chargers.
- Batteries must never be charged.
- Never use or charge a defective, damaged or deformed battery.
- Do not use any other power supply units that do not comply with the technical specifications. Doing so may shorten the life of the battery or even cause an electric shock, which may damage the appliance or cause a fire.
- If the appliance is not used for a long period of time, the external power supply should be disconnected to prevent the appliance from burning and causing a fire.
- If you do not use the device for a long time, you should charge it every two weeks, otherwise the internal battery is easily damaged, making it impossible to use the device again

⚠ WARNING



Risk of injury from falling parts!

Falling parts can cause serious injuries.

- Only use suitable and technically sound lifting gear.
- Use lifting gear with sufficient lifting capacity.
- Fasten individual parts and larger assemblies carefully using lifting gear.
- Secure individual parts and larger assemblies with lifting gear.
- Ensure that the hoist cannot pose a hazard.
- Lift individual parts and larger assemblies slowly!

CAUTION

- Keep a sufficient distance from heat sources.
- Do not use the device in environments with high humidity or water mist.

! NOTE

- To avoid damaging the device, do not expose it to extreme temperatures, extreme humidity or moisture.
- Do not use abrasive cleaners, scouring agents or solvents to clean the appliance.

6 Transportation and storage

6.1 Note

If you store or transport the device improperly, the device may be damaged. Observe the information on transporting and storing the appliance.

6.2 Transportation

When transporting the device, use the transport case included in the scope of delivery to protect the device from external influences.

6.3 Storage

Observe the following storage conditions when the appliance is not in use:

- dry and protected from frost and heat
- protected from dust ingress in the transport case
- the storage temperature corresponds to the technical data

6.4 Packaging/return transportation

Returns are only possible within the limits of the general terms and conditions. Keep all parts of the original packaging for any necessary return transportation.

- Only the original packaging is to be used for return transportation.
- Disconnect all connected cables and loose/movable parts before shipping.
- Refit any transportation locks provided.
- Secure all parts against slipping and damage.

7 Unpacking and commissioning

7.1 Unpacking



In the event of a return, please observe the instructions in the chapter "Packaging/return transportation"

On receipt of the appliance, please check in advance that no damage has occurred during transportation, that the outer packaging, the housing, other parts or even the appliance itself have not been damaged. If any damage is evident, please notify SAUTER GmbH immediately.

7.2 Initial commissioning

To ensure the function of the measuring device, it must be fully charged in the charging station using the mains adapter supplied before use.

8 Menu

8.1 Display indication

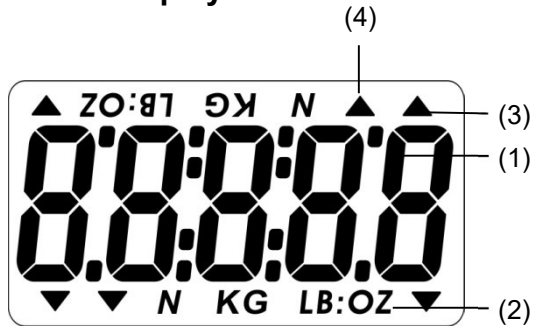

Position	Description
1	Measurement result
2	Display unit of the measurement result
3	Measuring direction (push/pull)
4	Display of the PEAK (peak measurement) mode

8.2 Control buttons



ON / OFF:

- On / Off button (press button for approx. 1 s)



MAX:

- Switch to PEAK (peak value) mode



UNIT (measuring units):

- Press the button briefly: Selection between N, kg, lb and oz



ZERO: Zero position

Assignment with three functions

- Zero setting of the display (tare function)
- Zeroing the peak value (Peak)
- Saving a setting (in SET mode)

8.3 Invert the display by 180°

If the device itself is rotated by 180°, the display also rotates automatically.

9 Adjustment

1. Stable external working conditions must be ensured.
A short warm-up phase of the device of approx. 1 minute is recommended for stabilization.

The FK is switched on by pressing the **"ON/OFF"** button. The appliance is in the hanging position.



2. As soon as "0" appears on the display, press the **"UNIT"** button and the **"ZERO"** button simultaneously until **"CAL"** appears on the display.



3. After a few seconds, the required **calibration weight** appears on the display, e.g. 5.00 kg for the FK 50 or 10.00 kg for the FK 100.



4. The corresponding weight is now attached to the hook. The device **must be held still while the weight is attached**; avoid shaking. Tip: hold the device with both hands while resting both elbows on a table or attach it to a fixed object (test stand).



5. This position is held until **"F"** appears on the display. The weight can then be removed and the adjustment is complete. However, if **"E"** appears on the display, repeat steps 1 to 5 until a successful adjustment is confirmed with **"F"**.

10 Battery operation / power supply

⚠ WARNING



Risk of fire and explosion due to incorrect charging or defective battery



Fire or explosion can lead to serious injuries

- ⇒ Be sure to observe the information on rechargeable batteries and batteries in the Safety chapter.
- ⇒ Observe the national and international transportation regulations for devices with a permanently installed lithium-ion battery.
- ⇒ Do not replace defective batteries yourself! Contact SAUTER or a specialist dealer directly.

The battery should be fully charged before first use. Use the mains adapter supplied for this purpose.

Optionally available in mains or battery operation

Main operation:

- Connection to mains via mains adapter

Battery operation for mobile use:

- Type: 6x 1.5 V AA batteries (alkaline (manganese))
- Not rechargeable! Batteries must be replaced if necessary

11 Maintenance, servicing and disposal



Disconnect the appliance from the power supply before carrying out any maintenance, cleaning or repair work.

11.1 Cleaning

Clean the device with a damp, soft, lint-free cloth. Make sure that no moisture penetrates the housing. Do not use sprays, solvents, alcohol-based cleaners or abrasive cleaners, but only clear water to moisten the cloth.

11.2 Maintenance and repair

Do not make any changes to the appliance and do not install any spare parts. Contact the manufacturer for repair or device inspection.

11.3 Waste disposal



Old appliances and accessories should not be disposed of with household waste.

The operator must dispose of the packaging and appliance in accordance with the applicable national or regional legislation at the place of use.

The device consists of various components and materials, such as

- Electronic components (circuit boards, electrical cables)
- Plastic (housing)
- Metal

Improper disposal of the appliance can have harmful effects on people and the environment.

Proper and environmentally friendly disposal can prevent harmful effects and recover raw materials.

Disposal of rechargeable batteries and batteries:

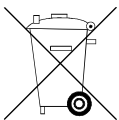

Rechargeable batteries and batteries do not belong in household waste.

The disposal of rechargeable batteries and batteries must be carried out by the operator in accordance with the applicable national or regional law of the place of use.

12 Battery law

Note in accordance with the Battery Act - BattG:

INFORMATION



- The following information is valid for Germany.

In connection with the sale of batteries and rechargeable batteries, we are obliged as a dealer under the Battery Act to inform end users of the following:

- End users are legally obliged to return used batteries and rechargeable batteries.
- After use, batteries and rechargeable batteries can be returned free of charge to municipal collection points or retailers. The normal end of use of the batteries/rechargeable batteries must be reached, otherwise precautions against short circuits must be taken.
- The return option is limited to batteries and rechargeable batteries of the type that we carry or have carried in our range and to the quantity that end consumers usually dispose of.
- A crossed-out waste garbage can means that you must not dispose of batteries or rechargeable batteries in household waste under any circumstances. Old batteries or rechargeable batteries may contain harmful substances that can damage people and the environment if not disposed of correctly.

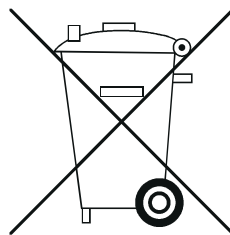

- Batteries containing harmful substances are marked with a symbol consisting of a crossed-out dustbin and the chemical symbol (Cd = cadmium, Hg = mercury, or Pb = lead) of the heavy metal responsible for the classification as containing harmful substances.

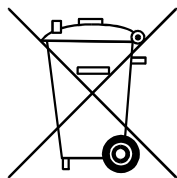

Cd

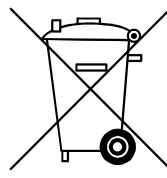

Hg

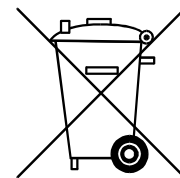

Pb