

Operating instructions

Set for density determination for analytical and precision balances

KERN ALT-B, PLT-A, PLT-F, ALS-A / ALJ-A,
PLS-A / PLJ-A, PLS-F / PLJ-F, PLE-N

KERN ALT-A02 / PLT A01

Version 1.0

01/2013

GB

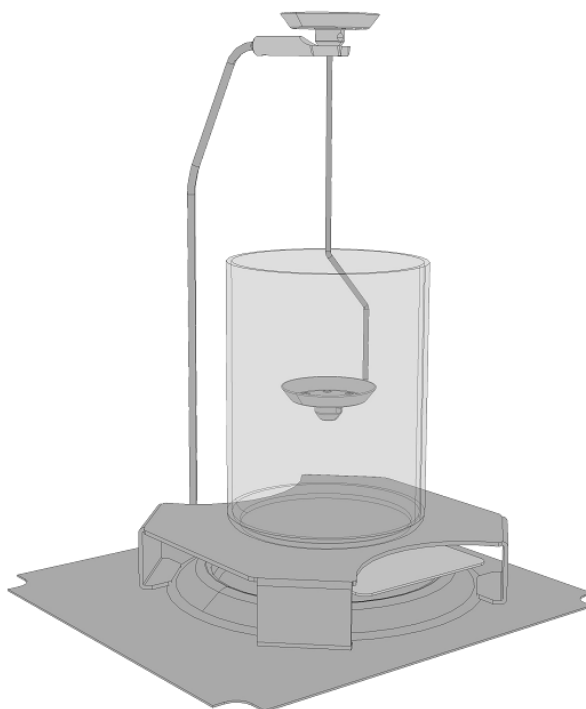



KERN ALT-A02 / PLT A01

Version 1.0 01/2013

Operating instructions

Set for density determination for analytical and precision balances KERN ALT-B, PLT-A, PLT-F, ALS-A / ALJ-A, PLS-A / PLJ-A, PLS-F / PLJ-F, PLE-N

Contents:

1	INTRODUCTION	3
1.1	SCOPE OF DELIVERY	4
2	PRINCIPLE OF DENSITY DETERMINATION.....	5
2.1	INFLUENCING MAGNITUDES AND ERROR SOURCES	6
3	HOW TO PREPARE THE WEIGHING BALANCE	7
4	INSTALLING THE DENSITY DETERMINATION SET	8
5	DENSITY DETERMINATION OF SOLIDS.....	10
5.1	BALANCES WITH GRAPHIC DISPLAY (KERN ALT-B, PLT-A, PLT-F)	13
5.2	BALANCES WITH LCD DISPLAY (KERN ALS-A / ALJ-A, PLS-A / PLJ-A, PLS-F / PLJ-F, PLE-N) 17	
6	DETERMINING DENSITY OF LIQUIDS	20
6.1	BALANCES WITH GRAPHIC DISPLAY (KERN ALT-B, PLT-A, PLT-F)	21
6.2	BALANCES WITH LCD DISPLAY (KERN ALS-A / ALJ-A, PLS-A / PLJ-A, PLS-F / PLJ-F, PLE-N) 25	
7	PRECONDITIONS FOR PRECISE MEASUREMENTS.....	28
7.1	CALCULATION OF RESULTS	28
7.2	INFLUENCE FACTORS FOR MEASUREMENT ERRORS	28
7.2.1	Air bubbles	28
7.2.2	Temperature	28
7.2.3	Solid matter sample	29
7.2.4	Liquids.....	29
7.2.5	Surface.....	29
7.3	GENERAL INFORMATION.....	29
7.3.1	Density / Relative Density.....	29
7.3.2	Drift of Balance Display	29
8	DENSITY TABLE FOR LIQUIDS	30
9	USER INSTRUCTIONS.....	31

1 Introduction

The density sets ALT-A02 and PLT-A01 differ in the support of the weighing plate. For the density set suitable for your balance, please refer to the following overview.









KERN ALT-A02	KERN PLT-A01
Set for density determination for analytical and precision balances d= 0.1 mg / 1 mg	Set for density determination for precision balances d= 10 mg
KERN ALT-B / PLT-A / PLT-F, ALS-A / ALJ-A, PLS-A / PLJ-A, PLS-F / PLJ-F, PLE-N	KERN PLT-A, PLT-F PLS-A / PLJ-A, PLS-F / PLJ-F

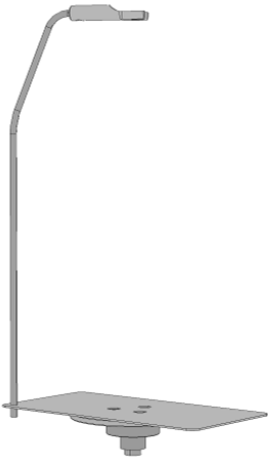

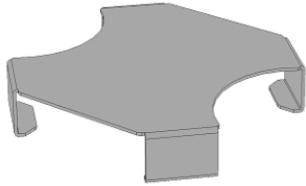
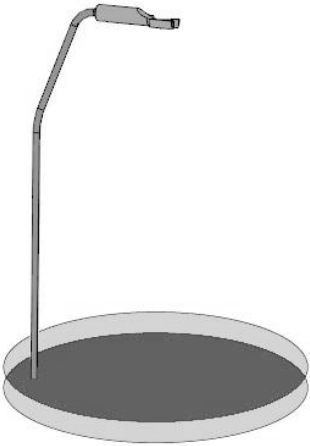
- In order to guarantee a safe and trouble-free operation, please read carefully the operating instructions.
- These operating instructions only describe the operation of the density determination set. For further information on how to operate your balance please refer to the operating instructions supplied with each balance.

1.1 Scope of delivery

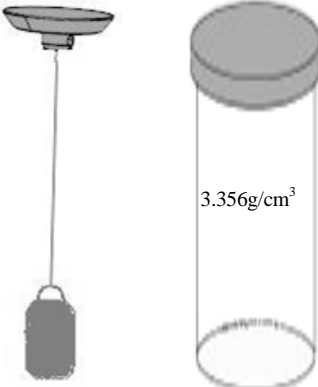
- ⇒ Check packaging and density determination set immediately when unpacking for possible visible damage.
- ⇒ Make sure that all parts are completely present.

		
<p>Retainer of immersion basket</p>	<p>Universal immersion basket for floating and descending solid matter</p>	<p>Platform for glass container</p>
	 <p>Ø 70 mm, 95 mm high</p>	 <p>Ø 55 mm, 150 mm high</p>
<p>Retainer for sinker</p>	<p>Glass beaker for density determination „solid matter“</p>	<p>Glass beaker for density determination „liquid“</p>
	 <p>3.356g/cm³</p>	
<p>Thermometer</p>	<p>Sinker with storage box</p>	<p>Allen key</p>

2 Principle of Density Determination

Three physical magnitudes are the **volume** and the **mass** of bodies as well as the **density** of matter. In density mass and volume are related.

Density [ρ] is the relation of mass [m] to volume [V].

$$\rho = \frac{m}{V}$$

SI-unit of density is kilogram divided by cubic meter (kg/m^3). $1 \text{ kg}/\text{m}^3$ equals the density of a homogenous body that, for a mass of 1 kg, has the volume of 1 m^3 .

Additional frequently applied units include:

$$1 \frac{\text{g}}{\text{cm}^3}, 1 \frac{\text{kg}}{\text{m}^3}, 1 \frac{\text{g}}{\text{l}}$$

The application of this density determination set in combination with the KERN ABS/ABJ balances provides fast and safe determination of solids and liquids. Our set uses the "**Principle of Archimedes**" to determine density:

BUOYANCY IS A FORCE. IT AFFECTS A BODY THAT IS IMMERSSED INTO A LIQUID. THE BUOYANCY OF THE BODY EQUALS THE WEIGHT FORCE OF THE DISPLACED LIQUID. THE FORCE OF BUOYANCY ACTS VERTICALLY UPWARDS.

Thus, density is calculated according to the formulae below:

To determine the density of solid matter

Our balances enable weighing of solids in air [A] as well as water [B]. If the density of the buoyancy medium is known [ρ_o] the density of the solid [ρ] is calculated as follows:

$$\rho = \frac{A}{A-B} \rho_o$$

ρ = Density of sample

A = Weight of the sample in air

B = Weight of the sample in the aid liquid

ρ_o = Density of the aid liquid

Determining density of liquids

The density of a liquid is determined with the help of a sinker providing a known volume [V]. The sinker is weighed in air [A] as well as in the test liquid [B]. According to the Archimedes' Principle a body immersed in a liquid experiences a force of buoyancy [G]. This force equals the weight force of the liquid displaced by the volume of the body.

The volume [V] of the immersed body equals the volume of the displaced liquid.

$$\rho = \frac{G}{V}$$

G = buoyancy of sinker

Buoyancy of sinker =

Weight of the sinker in air [A] - weight of sinker in test liquid [B]

From this follows:

$$\rho = \frac{A-B}{V}$$

ρ = density of sample liquid

A = weight of sinker in air

B = weight of the sinkers in test liquid

V = volume of sinker*

* If the volume of the sinker is unknown, this can be determined by a solid body density measurement e.g. in water and be calculated as follows.

$$V = \frac{A-B}{\rho_w}$$

V = volume of sinker

A = weight of sinker in air

B = weight of sinker in water

ρ_w = density of water

2.1 Influencing magnitudes and error sources

- ⇒ Air pressure
- ⇒ Temperature
- ⇒ Volume deviation of the sinker
- ⇒ Surface tension of the liquid
- ⇒ Air bubbles
- ⇒ Immersion depth of the sample dish or of the sinker
- ⇒ Porosity of the solid

3 How to prepare the weighing balance

When the density set is installed, correct adjustment is not possible.

Perform necessary adjustment before installation of the density set using the standard weighing plate.

If the balance is equipped with an internal adjustment weight (**ALT / PLT, ALJ-A, PLJ-A, PLJ-F**) carry out an internal adjustment. After adjustment, enable “external adjustment” in the adjustment mode menu. This will avoid a request of an internal adjustment, when the density set is installed.

If the balance is equipped with an external adjustment weight (**ALS-A, PLS-A, PLS-F, PLE-N**) carry out an external adjustment.

For carrying out please refer to the operating instructions supplied with each balance

4 Installing the density determination set

- i**
- When the density set is installed, correct adjustment is not possible.
 - For reasons of adjustment, take away the density set and place the standard weighing plate.

- ⇒ Disconnect scale from power supply.
- ⇒ Remove the standard weighing plate acc. to fig.

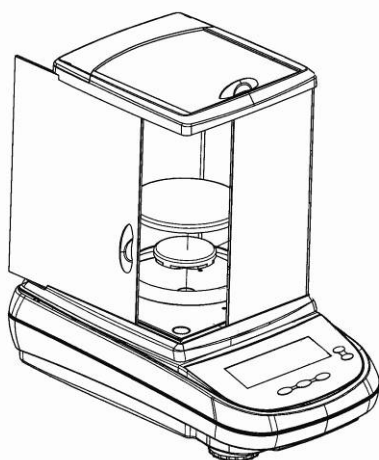

Models ALT, ALS/ALJ

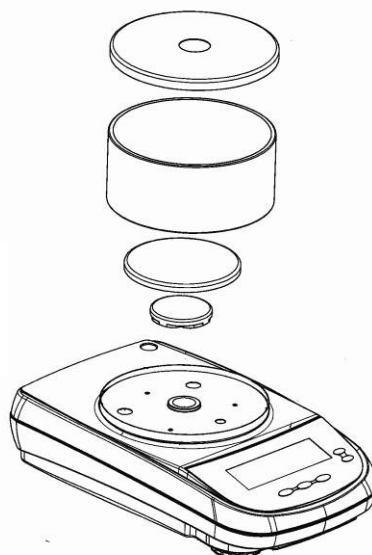

Models PLE, PLS/PLJ, PLT; $d = 0.1 \text{ mg} - 1 \text{ mg}$



Models PLS/PLJ, PLT; $d = 10 \text{ mg}$

- ⇒ Install density determination set
(for solid matter please see chap. 5, for liquids see chap. 6)

Installed density set for solid matter „precision balances“

$d = 10 \text{ mg}$

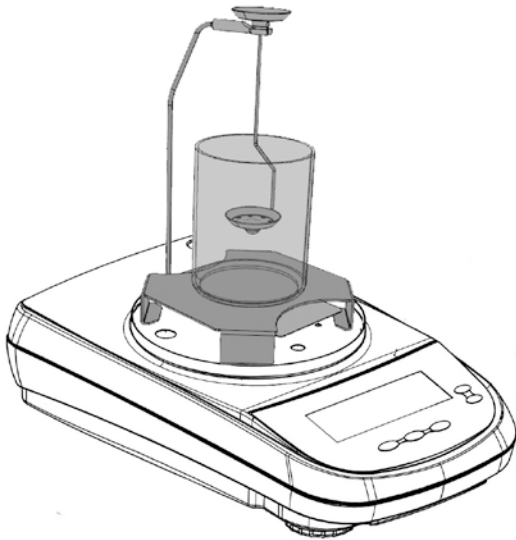

$d = 0.1 \text{ mg} - 1 \text{ mg}$

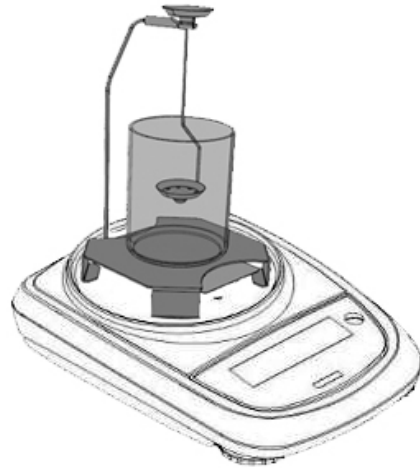

Installed density set for solid matter “analytical balances”

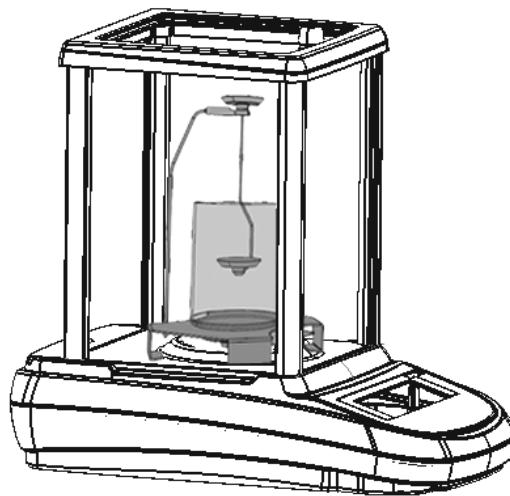

5 Density determination of solids

For the determination of the density of solids, the solid is first weighed in air and then in the aid liquid, whose density is known. From the weight difference results the buoyancy from where the software calculates the density.

As aid liquid, usually distilled water or ethanol is used, see density table chapter 8.

Prepare balance as described in chapter 3 "Installation of density determination set".

- ⇒ Place the retainer of the immersion basket on the cone of the weighing plate.
- ⇒ Place the platform for glass containers in a way that it does not touch the retainer of the immersion basket.
- ⇒ Place beaker in the centre of the platform Make sure that it has no contact with the retainer or with the immersion basket.
- ⇒ Hang the immersion basket on the retainer. Make sure that it is centred in the recess.
- ⇒ Fill the aid liquid into a glass beaker. Fill in so much liquid that the solid matter after immersion remains at least 1 cm under the liquid level. Immerse thermometer
- ⇒ Bring aid liquid / instruments / sample to the right temperature until you achieve a constant temperature. Observe the warm-up time of the balance.
- ⇒ Connect balance to power supply, the balance will carry out a self-test. Switch on using the **ON/OFF** button and wait until the gram display appears.

For determination of density of solid matter, the universal immersion basket for floating ($d > 1 \text{ g/cm}^3$) and descending solid matter ($d < 1 \text{ g/cm}^3$) must be used.

➤ $d > 1 \text{ g/cm}^3$

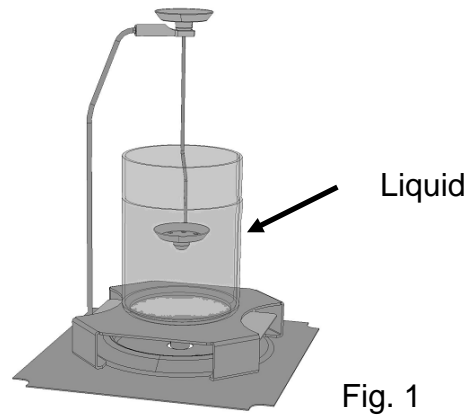

For descending solid matter suspend the immersion basket as shown in fig. 1.

➤ **$d < 1 \text{ g/cm}^3$**

At solid material with density less than 1 g/cm^3 , a density determination with two different methods is possible.

Method 1:

As aid liquid is used a liquid with less density than that of the solid material, e.g. ethanol approx. 0.8 g/cm^3 .

This method should be applied when the density of the solid is just slightly different from that of the distilled water.

Using ethanol is not recommended, when the solid material is being attacked.

⚠ When working with ethanol, you must observe the applicable safety regulations.

Method 2:

Here the sample is not placed upon, but **under** the sample dish. For that purpose the sample dish of the immersion basket must be assembled upside down as shown in fig. 2 with the help of the delivered Allen key.

If the buoyancy of the sample is so much that the immersion basket is lifted, place an additional weight on it in the upper sample dish and tare it away when weighing in air.

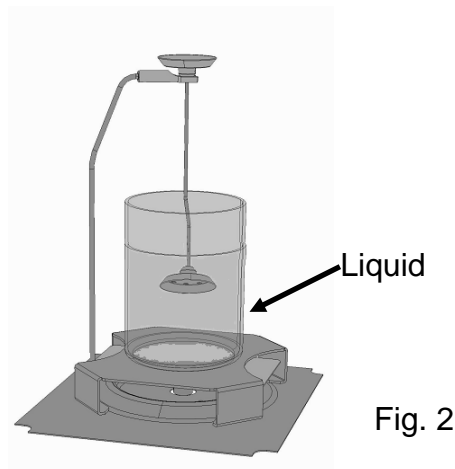

For floating solid matter suspend the immersion basket as shown in fig. 2.

5.1 Balances with graphic display (KERN ALT-B, PLT-A, PLT-F)

⇒ In weighing mode press **MENU** button. The master menu will be displayed.

⇒ Use the navigation buttons $\downarrow\uparrow$ to select the menu item „Density“.

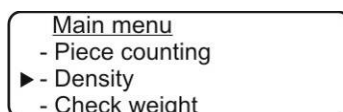

⇒ Acknowledge using **PRINT** button, the current setting is displayed.

⇒ Use the navigation buttons $\downarrow\uparrow$ to select setting „Solid body“.



⇒ Confirm using the **PRINT** button, the set density of the aid liquid is displayed (factory setting 1.0000 g/cm³ for distilled water at 20°C).

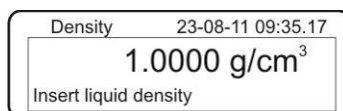

⇒ To change (see table chap. 8) press the **TARE** button.

To delete keep pressed the **TARE** button. Use the navigation buttons $\downarrow\uparrow$ to increase/reduce the digit. Use the **TARE** button to select the next digit. Repeat this sequence for each digit.

⇒ Confirm entry with **PRINT** button, the display for calculation of „Weight in air“ is displayed.

Should the balance not show Zero, press the **TARE** button.



⇒ Place sample in the upper sample dish.

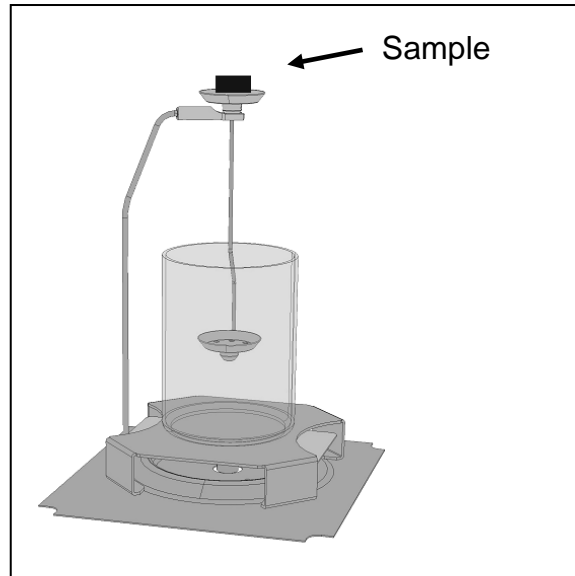

⇒ Wait for stability display [*****], then take over the weight value using the **PRINT** button.

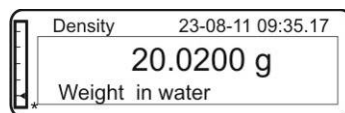

- ⇒ Wait until the display for determination of „sample in aid liquid“ appears. Remove the sample and if required tare by using the **TARE** button.
- ⇒ Lay the sample into the lower sample dish and immerse it in the aid liquid trying to avoid bubble formation.
Make sure that the sample is at least 1 cm immersed.

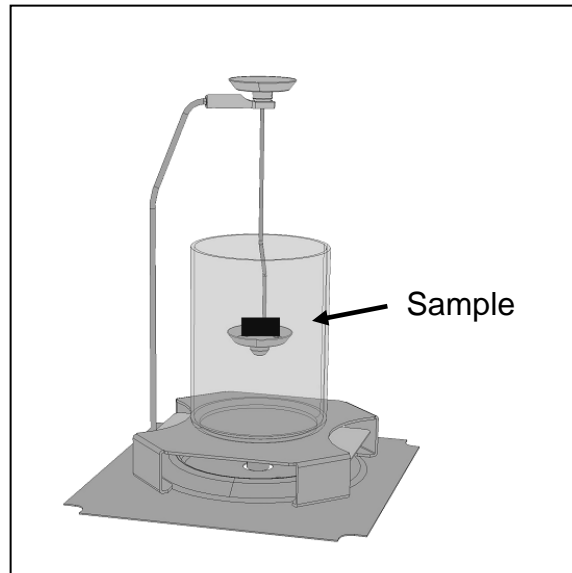

- ⇒ Wait for stability display [*****], take over the weight value using **PRINT** button. The density of the sample is shown.

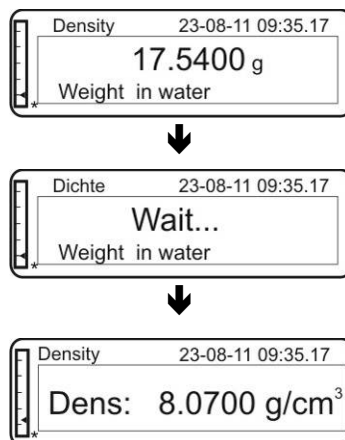

⇒ When an optional printer is connected, the displayed value can be edited using the **PRINT** button.

Printout example (KERN YKB-01N):

.....
07-09-11 11:14:57
.....
d : 8.0700 g/cm ³

If at the density determination errors have appeared, „d-----“, is displayed.

i

Density	23-08-11 09:35.17
Dens: -----	g/cm ³

⇒ For further measurements go back to density determination mode, press **MENU** button.

Density	23-08-11 09:35.17
Solid	
Select mode	

⇒ Back to weighing mode, press **ON/OFF** button.

	23-08-11 09:35.17
	0.0000 g
*-0-	

5.2 Balances with LCD display (KERN ALS-A / ALJ-A, PLS-A / PLJ-A, PLS-F / PLJ-F, PLE-N)

⇒ In weighing mode press **MENU** button. The first menu item „count“ is displayed.

The LCD display shows the word "Count" in a large, black, monospaced font.

⇒ Press **MENU** button

The LCD display shows "dEnS" in a large, black, monospaced font.

⇒ Acknowledge using **PRINT** button, the current setting is displayed.

⇒ Using **MENU** button select „d SoLid“

The LCD display shows "dSoL id" in a large, black, monospaced font.

⇒ Confirm by pressing the **PRINT** button. The currently set density of the aid liquid is displayed (factory setting 1.0000 g /cm³ for distilled water at 20°C).

The LCD display shows "dL 1.0000" in a large, black, monospaced font.

⇒ To change, enter the density of the aid liquid using arrow keys ↓ ↑ ←.

⇒ Confirm input by pressing the **PRINT** button.

⇒ The display for weight determination of the "sample in air" appears.

UE , A ir

⇒ Confirm by pressing the **PRINT** button.

⇒ Should the balance not show Zero, press the **TARE** button.

⇒ Lay the solid matter in the upper sample dish.

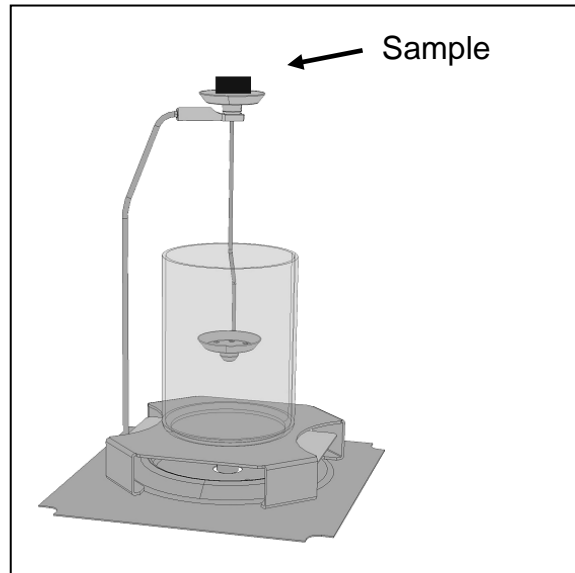

⇒ Wait for stability display [*****], then take over the weight value „sample in air“ using the **PRINT** button.

⇒ Wait until the display for weight determination of „sample in aid liquid“ appears.

UE , LI 9

⇒ Confirm by pressing the **PRINT** button.

⇒ Remove the sample and if required tare by using the **TARE** button.

- ⇒ Lay the sample into the lower sample dish and immerse it in the aid liquid trying to avoid bubble formation.
Make sure that the sample is at least 1 cm immersed.

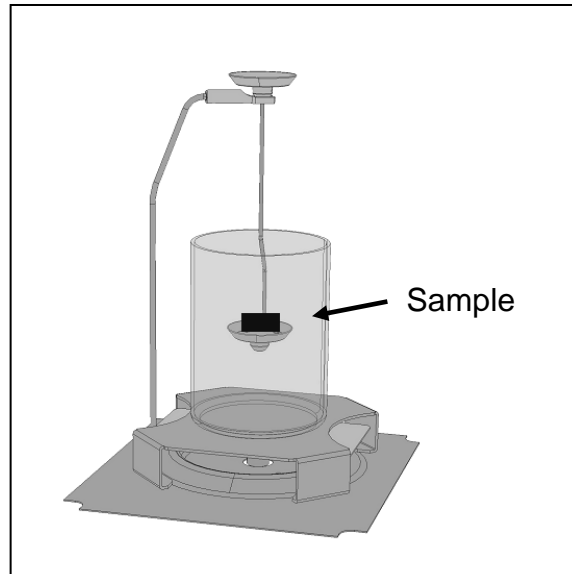

- ⇒ Wait for stability display [*****], then take over the weight value „sample in aid liquid“ using the **PRINT** button. The density of the sample is shown.



- ⇒ When an optional printer is connected, the displayed value can be edited using the **PRINT** button.

Printout example (KERN YKB-01N):

$d : 2.0000 \text{ g/cm}^3$

Return to weighing mode

- ⇒ Press the **ON/OFF** button



- ⇒ or use the **MENU** button to start a new measuring cycle.

If at the density determination errors have appeared, „d-----“, is displayed.

i

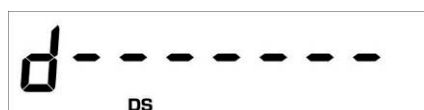

6 Determining density of liquids

At the density determination of liquids, a glass sinker is used whose density is known. The glass sinker is weighed first in air and then in the liquid whose density is to be determined. From the weight difference results the buoyancy from where the software calculates the density.

Prepare balance as described in chapter 3 "Installation of density determination set".

- ⇒ Place the retainer of the immersion basket on the cone of the weighing plate.
- ⇒ Place the platform for glass containers in a way that it does not touch the retainer of the immersion basket.
- ⇒ Place a high glass beaker in the centre of the platform. Suspend thermometer.

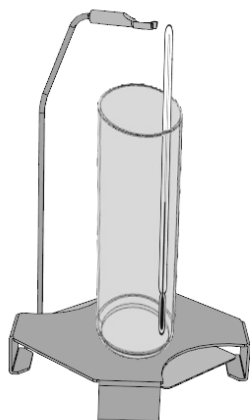

- ⇒ Keep the sinker ready

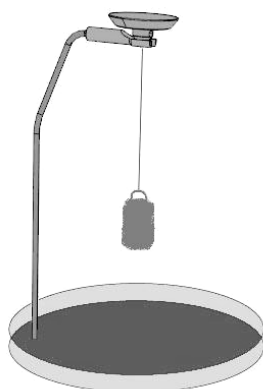

- ⇒ Bring test liquid / instruments / sinker to the right temperature until you achieve a constant temperature. Observe the warm-up time of the balance.
- ⇒ Connect the balance to the power supply, the balance carries out a self-test. Switch on by the **ON/OFF** button and wait until the gram display appears.

6.1 Balances with graphic display (KERN ALT-B, PLT-A, PLT-F)

- ⇒ In weighing mode press **MENU** button. The master menu will be displayed.
- ⇒ Use the navigation buttons \updownarrow to select the menu item „Density“.

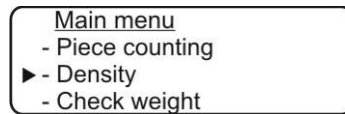

- ⇒ Acknowledge using **PRINT** button, the current setting is displayed.
- ⇒ Use the navigation buttons \updownarrow to select the setting „Liquid“.



- ⇒ Confirm using the **PRINT** button, the currently set density of the sinker is displayed (factory setting 3.0000 g/cm^3).

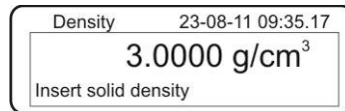

- ⇒ Read off the density of the sinker on the storage box and enter it. To delete keep pressed the **TARE** button. Use the navigation buttons \updownarrow to increase/reduce the digit. Use the **TARE** button to select the next digit. Repeat this sequence for each digit.

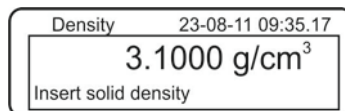
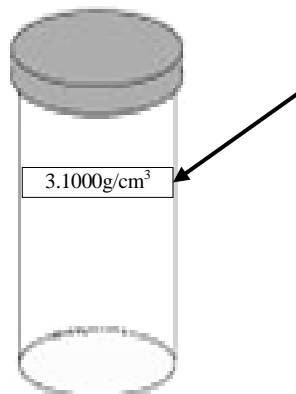

- ⇒ Confirm by pressing the **PRINT** button. The display for weight determination of the "Sinker in air" appears.

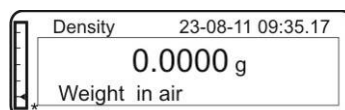

- ⇒ If weighing balance does not show Zero, press **TARE**.

⇒ Attach the sinker.

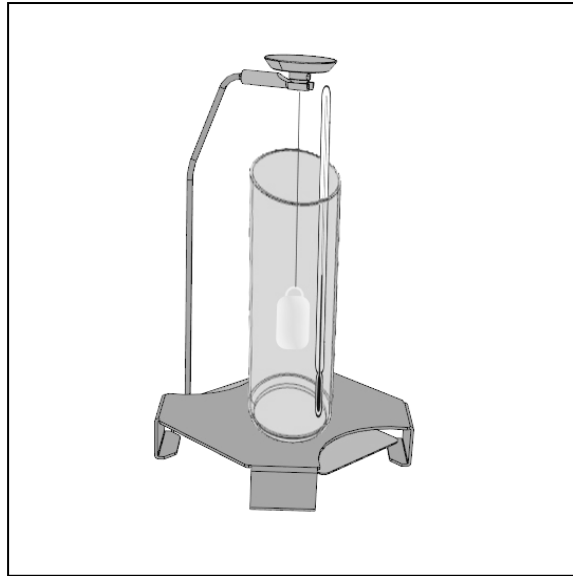

⇒ Wait for stability display [*****], take over the weight value using **PRINT** button

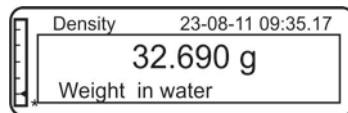
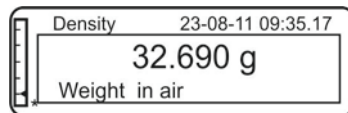

⇒ Wait until the display for weight determination of „sinker in test liquid“ appears. Remove the sinker and if required tare by using the **TARE** button.

⇒ Fill the glass beaker with test liquid

- ⇒ If possible, immerse the sinker bubble-free in the test liquid.
Make sure that the sinker is at least 1 cm immersed.

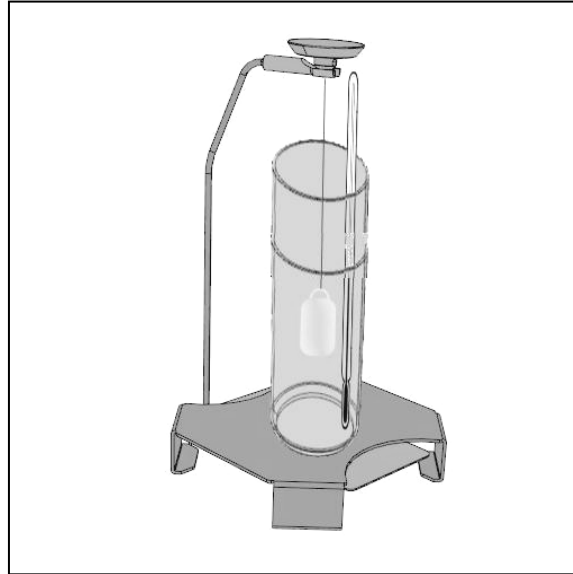

- ⇒ Wait for stability display [*****], take over the weight value using **PRINT** button. The density of the test liquid is shown at the temperature displayed by the thermometer.



If at the density determination errors have appeared, „d-----“, is displayed.

i

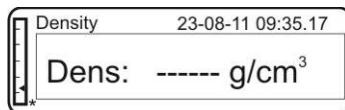

⇒ When an optional printer is connected, the displayed value can be edited using **PRINT**.

Printout example (KERN YKB-01N):

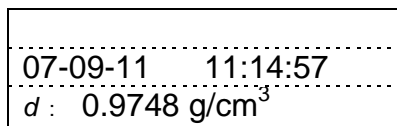

⇒ For further measurements go back to density determination mode, press **MENU** button.



⇒ Back to weighing mode, press **ON/OFF** button.



6.2 Balances with LCD display (KERN ALS-A / ALJ-A, PLS-A / PLJ-A, PLS-F / PLJ-F, PLE-N)

⇒ In weighing mode press **MENU** button. The first menu item „count“ is displayed.

The LCD display shows the word "Count" in a large, black, monospaced font.

⇒ Press **MENU** button

The LCD display shows "dEn5" in a large, black, monospaced font.

⇒ Acknowledge using **PRINT** button, the current setting is displayed.

⇒ Using **MENU** button select „d Liquid“

The LCD display shows "dL 190 1d" in a large, black, monospaced font.

⇒ Confirm using the **PRINT** button, the currently set density of the sinker is displayed (factory setting 3.0000 g/cm³).

The LCD display shows "d5 3.0000" in a large, black, monospaced font.

⇒ Read off and enter the density of the sinker on the storage box or suspension bracket. To delete keep pressed the **TARE** button. Use the navigation buttons \updownarrow to increase/reduce the digit. Use the **TARE** button to select the next digit. Repeat this sequence for each digit.

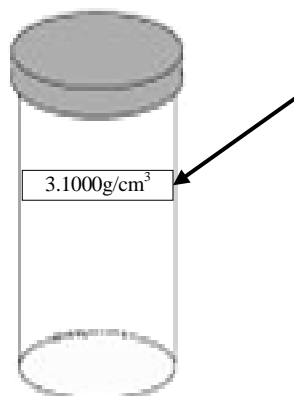

- ⇒ Confirm input by pressing the **PRINT** button. The display for weight determination of the "Sinker in air" appears.



- ⇒ Confirm by pressing the **PRINT** button.
If weighing balance does not show Zero, press **TARE**.
- ⇒ Attach the sinker centrally.

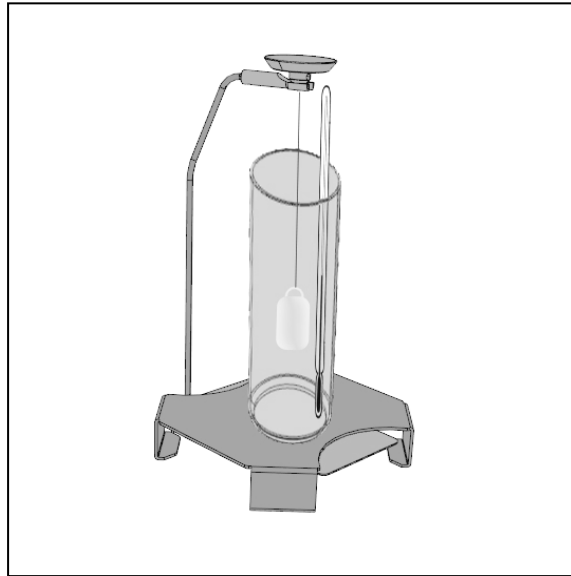

- ⇒ Wait for stability display [*****], take over the weight value „sinker in air“ using the **PRINT** button.
- ⇒ Wait until the display for weight determination of „sinker in test liquid“ appears.

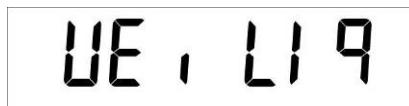

- ⇒ Confirm by pressing the **PRINT** button.
- ⇒ Remove the sinker and if required tare by using the **TARE** button.
- ⇒ Fill the glass beaker with test liquid

- ⇒ If possible, immerse the sinker bubble-free in the test liquid. Make sure that the sinker is at least 1 cm immersed.

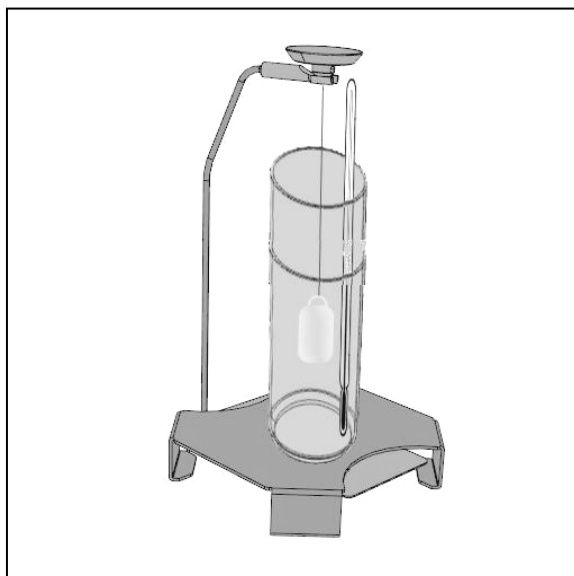

- ⇒ Wait for stability display [*****], take over the weight value „sinker in test liquid“ using the **PRINT** button. The density of the test liquid is shown at the temperature displayed by the thermometer.



- ⇒ When an optional printer is connected, the displayed value can be edited using the **PRINT** button.

Printout example (KERN YKB-01N):

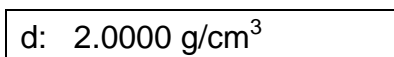

Return to weighing mode

- ⇒ Press the **ON/OFF** key



- ⇒ or use the **MENU** button to start a new measuring cycle.

If at the density determination errors have appeared, „d-----“, is displayed.

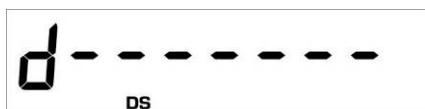

7 Preconditions for Precise Measurements

There are numerous error possibilities during density determination. Accurate knowledge and caution are required to achieve precise results when applying this density set in combination with the balance.

7.1 Calculation of Results

The balance displays results for density determination by giving four decimal places. However, this does not mean that the results are accurate down to the last decimal place as this would be the case for a calculated value. Therefore all weighing results used for calculations have to be examined closely.

Example for density determination of solids:

To ensure high-grade results, numerators as well as common denominators of the formula below must show the desired accuracy. If either of them is instable or flawed, the result, too, will be instable or flawed.

$$\rho = \frac{A}{A-B} \rho_0$$

ρ = Density of sample

A = Weight of the sample in air

B = Weight of the sample in the aid liquid

ρ_0 = Density of the aid liquid

7.2 Influence Factors for Measurement Errors

7.2.1 Air bubbles

A small bubble with a diameter of 1 mm results in a buoyancy of 0.5 mg, while those with 2 mm \varnothing already produces a buoyancy of 4 mg.

Therefore, make sure that no air bubbles adhere on the solid object or sinker that is immersed in the liquid.

An oily surface causes air bubbles when immersing in the liquid, so

- remove grease from solvent resistant solid matter sample
- clean all parts that are immersed regularly and don't touch them with bare fingers

Don't lay solid samples (particularly flat objects) outside of the liquid on the sample bowl, because this results in air bubbles by the joint immersion.

7.2.2 Temperature

Normally solid matter is insensitive to temperature changes, therefore the respective changes of density can be ignored. Nevertheless the temperature of the liquid used for density determination of solid matter must be taken into consideration as any temperature change by one degree $^{\circ}\text{C}$ causes a change of density from 0.1 to 1%. This has an effect on the third decimal point of the result.

7.2.3 Solid matter sample

A sample possessing too great a volume that is immersed in liquid will result in an increase in liquid level inside the glass pitcher. As a result, part of the suspension bracket of the sample dish will also be immersed causing buoyancy to increase. As a consequence the weight of the specimen in the liquid will drop.

Samples that change the volume or assimilate liquid are unsuitable for measurement.

7.2.4 Liquids

Solids are generally not sensitive to temperature changes, so that the corresponding density changes are not relevant. However, since you work with an aid liquid by the density determination of solids, according to the "Archimedean Principle", its temperature is taken into account. The temperature change effects liquids greater and causes changes in the density in order of 0.1 to 1 ‰ per °C. Hereby, the third digit after the decimal point is affected.

7.2.5 Surface

The suspension bracket of the sample dish penetrates the surface of the liquid. This state undergoes continuous change. If the sample or the sinker is relatively small, the surface tension will impair repeatability. Adding a small amount of tenside (detergent) makes surface tension negligible and increases reproducibility.

7.3 General information

7.3.1 Density / Relative Density

Relative density follows from the weight of a specimen divided by the weight of water (at 4° Celsius) of the same volume. For this reason relative density does not have a unit. Density equals mass divided by volume.

The application of the relative density instead of the density of a liquid in a formula produces an incorrect result. In the case of liquids only their density is physically meaningful.

7.3.2 Drift of Balance Display

The drifting of a balance does not influence the final result of the density determination although the shown weight of weighing in air is affected. Accurate values are merely required if the density of liquids is determined by means of a sinker.

When changing the ambient temperature or location, an adjustment of the balance is necessary. For this purpose, remove the density set and carry out adjustment using the standard weighing pan.

8 Density Table for Liquids

Temperature [°C]	Density ρ [g/cm ³]		
	Water	Ethyl alcohol	Methyl alcohol
10	0.9997	0.7978	0.8009
11	0.9996	0.7969	0.8000
12	0.9995	0.7961	0.7991
13	0.9994	0.7953	0.7982
14	0.9993	0.7944	0.7972
15	0.9991	0.7935	0.7963
16	0.9990	0.7927	0.7954
17	0.9988	0.7918	0.7945
18	0.9986	0.7909	0.7935
19	0.9984	0.7901	0.7926
20	0.9982	0.7893	0.7917
21	0.9980	0.7884	0.7907
22	0.9978	0.7876	0.7898
23	0.9976	0.7867	0.7880
24	0.9973	0.7859	0.7870
25	0.9971	0.7851	0.7870
26	0.9968	0.7842	0.7861
27	0.9965	0.7833	0.7852
28	0.9963	0.7824	0.7842
29	0.9960	0.7816	0.7833
30	0.9957	0.7808	0.7824
31	0.9954	0.7800	0.7814
32	0.9951	0.7791	0.7805
33	0.9947	0.7783	0.7896
34	0.9944	0.7774	0.7886
35	0.9941	0.7766	0.7877

9 User Instructions

- To form a reproducible mean value several density measurement are necessary
- Remove fat from solvent-resistant sample / /glass sinker /beaker.
- Regularly clean sample dishes/glass sinker/glass beaker, do not touch immersing part with your hands
- Dry sample/glass sinker/pincers after each measurement.
- Adjust sample size to sample dish (ideal sample size > 5 g).
- Only use distilled water.
- When immersing for the first time, lightly shake sample dishes and sinker, in order to dissolve air bubbles.
- Always ensure that, when re-immersing into the liquid no additional bubbles adhere; it is better to use pincers to place the sample.
- Remove firmly adherent air bubbles with a fine brush or a similar tool.
- To avoid adherent air bubbles smoothen samples with rough surface.
- Take care that no water drips onto the upper sample dish when weighing with the help of tweezers.
- In order to reduce the surface tension of water and the friction of the liquid on the wire, add three drops of a common detergent (washing-up liquid) to the measuring liquid (density modification of distilled water occurring due to the addition of tensides can be ignored).
- Oval samples can be held more easily with pincers when you cut grooves into them.
- The density of porous solids may only be determined approximately. Buoyancy errors occur when not all the air is eliminated from the pores during immersion in the measuring liquid.
- To avoid great vibrations of the balance, place sample carefully.
- Avoid static charge, e. g. dry glass sinker with cotton cloth only.
- If the density of your solid only deviates slightly from that of distilled water, ethanol may be used as measuring liquid. However, check beforehand whether the sample is solvent-proof. In addition you must observe the applicable safety regulations when working with ethanol.
- Handle glass sinker with care (no warranty claims in case of damage).
- To avoid corrosion, don't leave the density set immersed in liquid for a long time.